

IS142 Rev.02 24/01/2017

B70/1DCHP

centrale di comando per cancelli scorrevoli

Istruzioni originali



IT - Istruzioni ed avvertenze per l'installatore - pag. 14

EN - Instructions and warnings for the installer - pag. 41

DE - Anweisungen und Hinweise für den Installateur - S. 68

FR - Instructions et consignes pour l'installateur - p. 95

ES - Instrucciones y advertencias para el instalador - pág. 122

PT - Instruções e advertências para o instalador - pág. 149

 **ROGER**
TECHNOLOGY
AUTOMAZIONI EVOLUTE

IT	1	Avvertenze generali	14	FR	1	Consignes générales de sécurité	95
	2	Descrizione prodotto	14		2	Description produit	95
	3	Caratteristiche tecniche prodotto	15		3	Caractéristiques techniques produit	96
	4	Descrizione dei collegamenti	15		4	Description des raccordements	96
	4.1	Collegamenti elettrici	16		4.1	Raccordements électriques	97
	5	Tasti funzione e display	17		5	Touches fonction et écran	98
	6	Accensione o messa in servizio	17		6	Allumage ou mise en service	98
	7	Modalità funzionamento display	17		7	Modalités fonctionnement écran	98
	8	Apprendimento della corsa	20		8	Apprentissage de la course	101
	9	Indice dei parametri	21		9	Indice des paramètres	102
	10	Menù parametri	23		10	Menu paramètres	104
	11	Parametri speciali serie BG30/1000/HS	31		11	Paramètres spéciaux série BG30/1000/HS	113
	12	Parametri speciali serie BG30/1400/R	32		12	Paramètres spéciaux série BG30/1400/R	114
	13	Comandi e accessori	33		13	Commandes et accessoires	115
	14	Segnalazione degli ingressi di sicurezza e dei comandi (modalità TEST)	35		14	Signalisation des entrées de sécurité et des commandes (modalités TEST)	117
	15	Segnalazione allarmi e anomalie	36		15	Signalisations alarmes et anomalies	118
	16	Diagnostica - Modalità INFO	38		16	Diagnostic - Modalité info	120
	17	Sblocco meccanico	39		17	Déblocage mécanique	121
	18	Modalità di recupero posizione	39		18	Modalités de récupération position	121
	19	Collaudo	39		19	Test	121
	20	Manutenzione	40		20	Entretien	122
	21	Smaltimento	40		21	Élimination	122
22	Informazioni aggiuntive e contatti	40	22	Informations complémentaires et contacts	122		
23	Dichiarazione di Conformità	40	23	Déclaration de conformité	122		
EN	1	General safety precautions	41	ES	1	Advertencias generales	123
	2	Product description	41		2	Descripción del producto	123
	3	Technical characteristics of product	42		3	Características técnicas del producto	124
	4	Description of connections	42		4	Descripción de las conexiones	124
	4.1	Electrical connections	43		4.1	Conexiones eléctricas	125
	5	Function buttons and display	44		5	Teclas de función y pantalla	126
	6	Switching on or commissioning	44		6	Encendido o puesta en servicio	126
	7	Display function modes	44		7	Modo de funcionamiento de la pantalla	126
	8	Travel acquisition	47		8	Aprendizaje del recorrido	129
	9	Parameter's index	48		9	Índice de los parámetros	130
	10	Parameter menu	50		10	Menú de parámetros	132
	11	Special parameters for BG30/1000/HS series	58		11	Parámetros especiales de la serie BG30/1000/HS	140
	12	Special parameters for BG30/1400/R series	59		12	Parámetros especiales de la serie BG30/1400/R	141
	13	Commands and Accessories	60		13	Comandos y accesorios	142
	14	Safety input and command status (TEST mode)	62		14	Señalización de las entradas de seguridad y de los comandos (Modo TEST)	144
	15	Alarms and faults	63		15	Señalización de alarmas y anomalías	145
	16	Procedural verifications - INFO Mode	65		16	Diagnostica - Modo Info	147
	17	Mechanical release	66		17	Desbloqueo mecánico	148
	18	Position recovery mode	66		18	Modo de recuperación de la posición	148
	19	Initial testing	66		19	Ensayo	148
	20	Maintenance	67		20	Mantenimiento	149
	21	Disposal	67		21	Eliminación	149
22	Additional information and contact details	67	22	Información adicional y contactos	149		
23	Declaration of Conformity	67	23	Declaración de Conformidad	149		
DE	1	Allgemeine Sicherheitshinweise	68	PT	1	Advertências gerais	150
	2	Produktbeschreibung	68		2	Descrição do produto	150
	3	Technische Daten des Produkts	69		3	Caraterísticas técnicas do produto	151
	4	Beschreibung der Anschlüsse	69		4	Descrição das ligações	151
	4.1	Elektrische Anschlüsse	70		4.1	Ligações elétricas	152
	5	Funktionstasten und Display	71		5	Teclas de função e display	153
	6	Einschalten oder Inbetriebnahme	71		6	Ignição ou comissionamento	153
	7	Funktion Display	71		7	Modalidade de funcionamento do display	153
	8	Einlernen des Torlaufs	74		8	Aprendizagem do curso	156
	9	Index der Parameter	75		9	Índice dos parâmetros	157
	10	Menü Parameter	77		10	Menu de parâmetros	159
	11	Sonderparameter für die Baureihe BG30/1000/HS	85		11	Parâmetros especiais série BG30/1000/HS	167
	12	Sonderparameter für die Baureihe BG30/1400/R	86		12	Parâmetros especiais série BG30/1400/R	168
	13	Befehle und Zubehör	87		13	Comandos e acessórios	169
	14	Meldung der Sicherheitseingänge und der Befehle (TEST-Modus)	89		14	Sinalização das entradas de segurança e dos comandos (modalidade TEST)	171
	15	Meldung von Alarmen und Störungen	90		15	Sinalização de alarmes e anomalias	172
	16	Diagnostik - Betriebsart Info	92		16	Diagnosticar - Modo INFO	174
	17	Mechanische Entriegelung	93		17	Desbloqueio mecânico	175
	18	Modus zur Korrektur der Position	93		18	Modalidade de recuperação de posição	175
	19	Abnahmeprüfung	93		19	Teste	175
	20	Wartungsarbeiten	94		20	Descarte	176
	21	Entsorgung	94		21	Informações adicionais e contatos	176
22	Zusätzliche Informationen und Kontakte	94	22	Declaração de conformidade	176		
23	Konformitätserklärung	94					

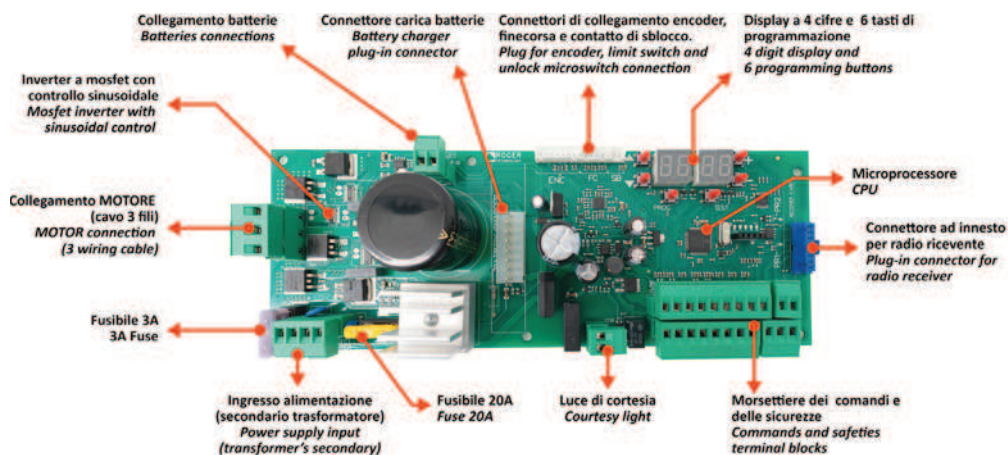

Firmware Rev r1.22

1

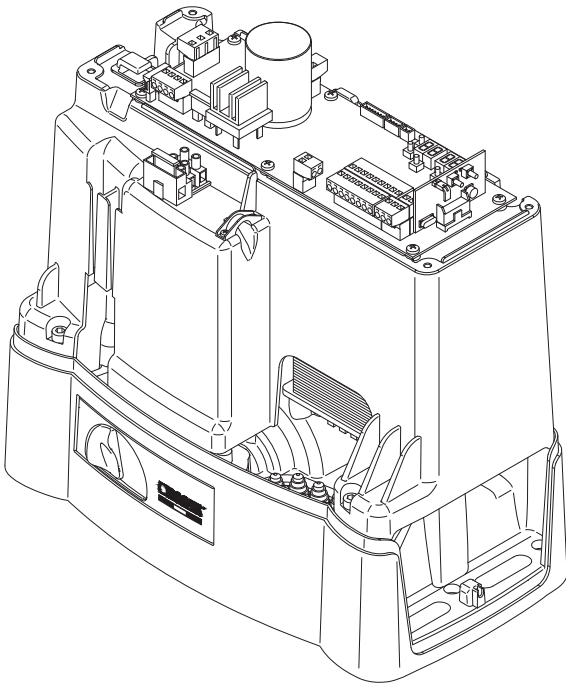
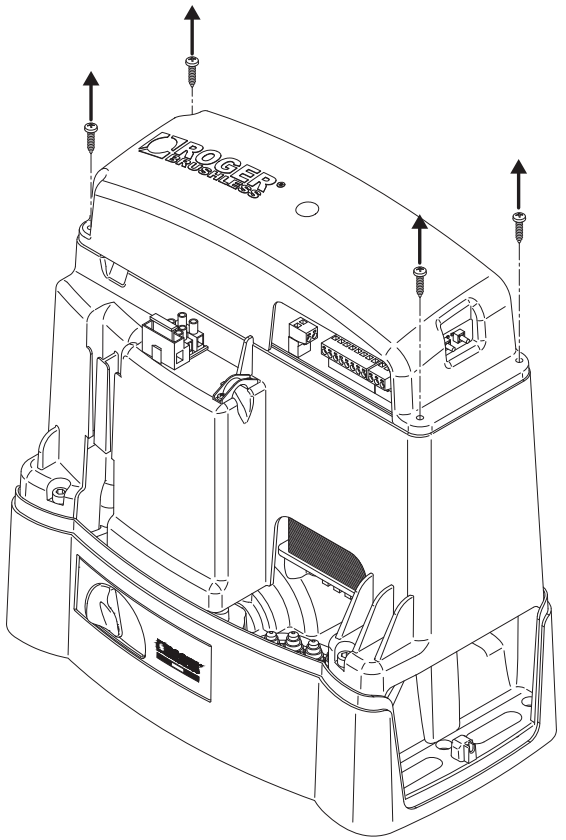

2

F3
FUSIBILE
FUSE
3A

F2
FUSIBILE
FUSE
T2A

Alimentazione
Power supply

A

F1
FUSIBILE
FUSE
20A

H93/RX22A/I
RICEVITORE RADIO
RADIO RECEIVER

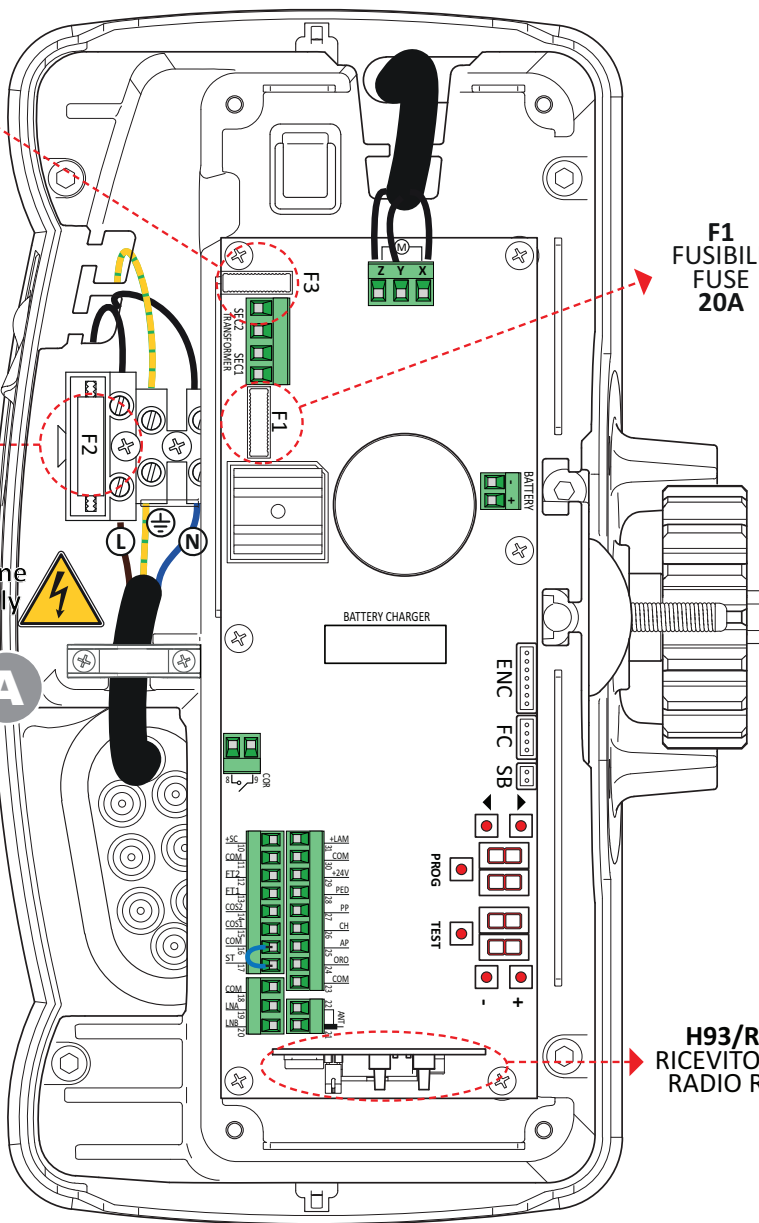
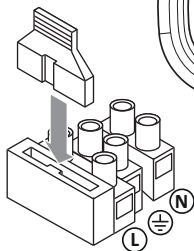

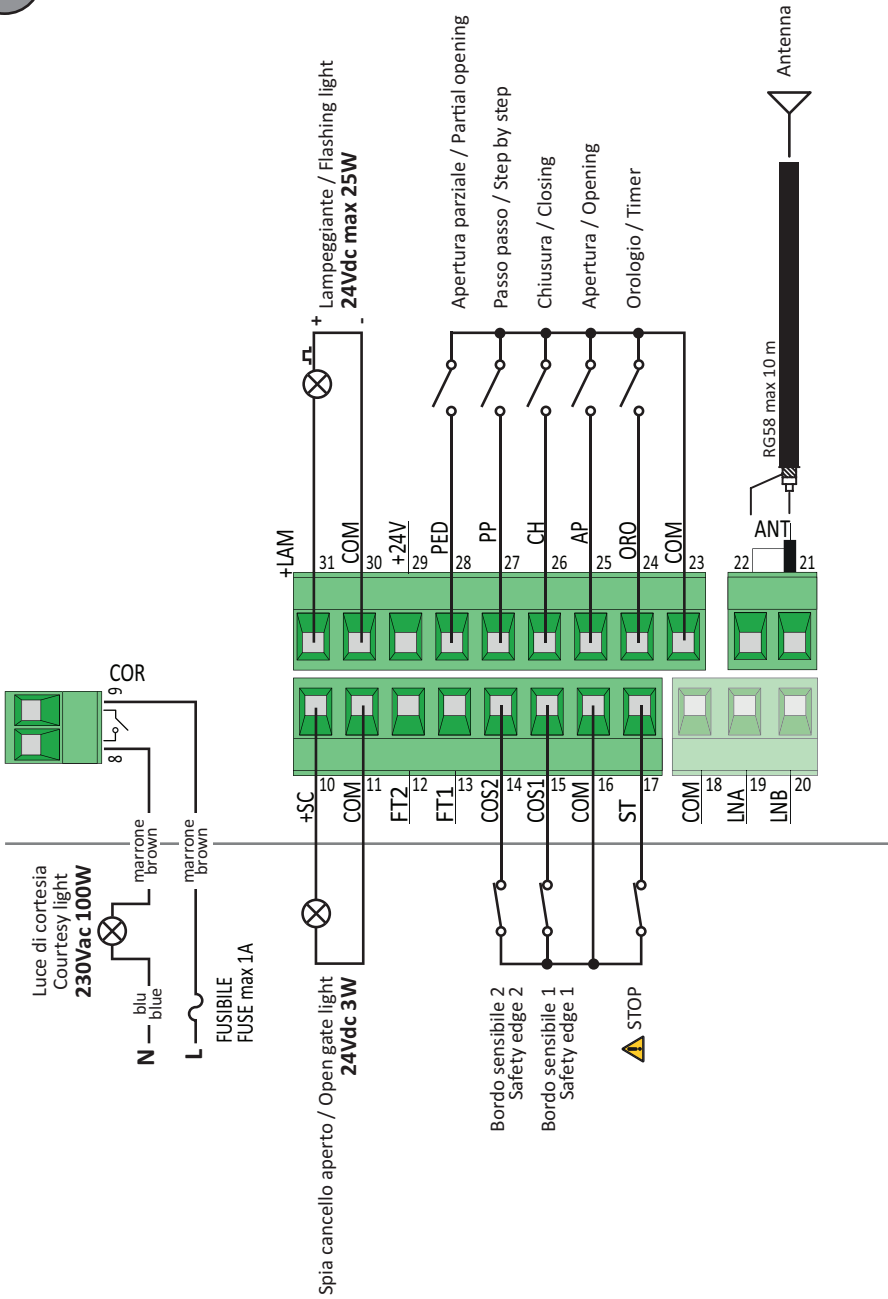

R90/F4ES
G90/F4ES
T90/F4S



USO RACCOMANDATO
RECOMMENDED USE

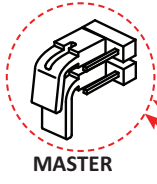

MASTER



SLAVE 1

FT1

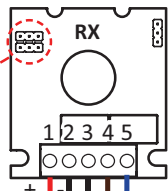
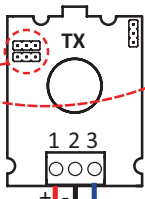

FT2

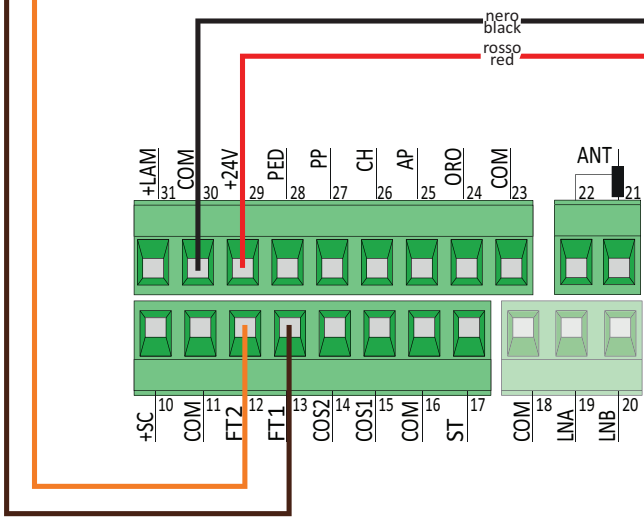
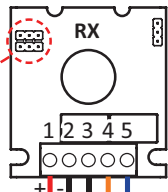
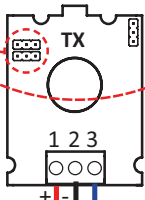

5

TEST FOTOCELLULE · PHOTOCELLS TEST (impostare · set AB 02)

R90/F4ES
G90/F4ES
T90/F4S



USO RACCOMANDATO
RECOMMENDED USE

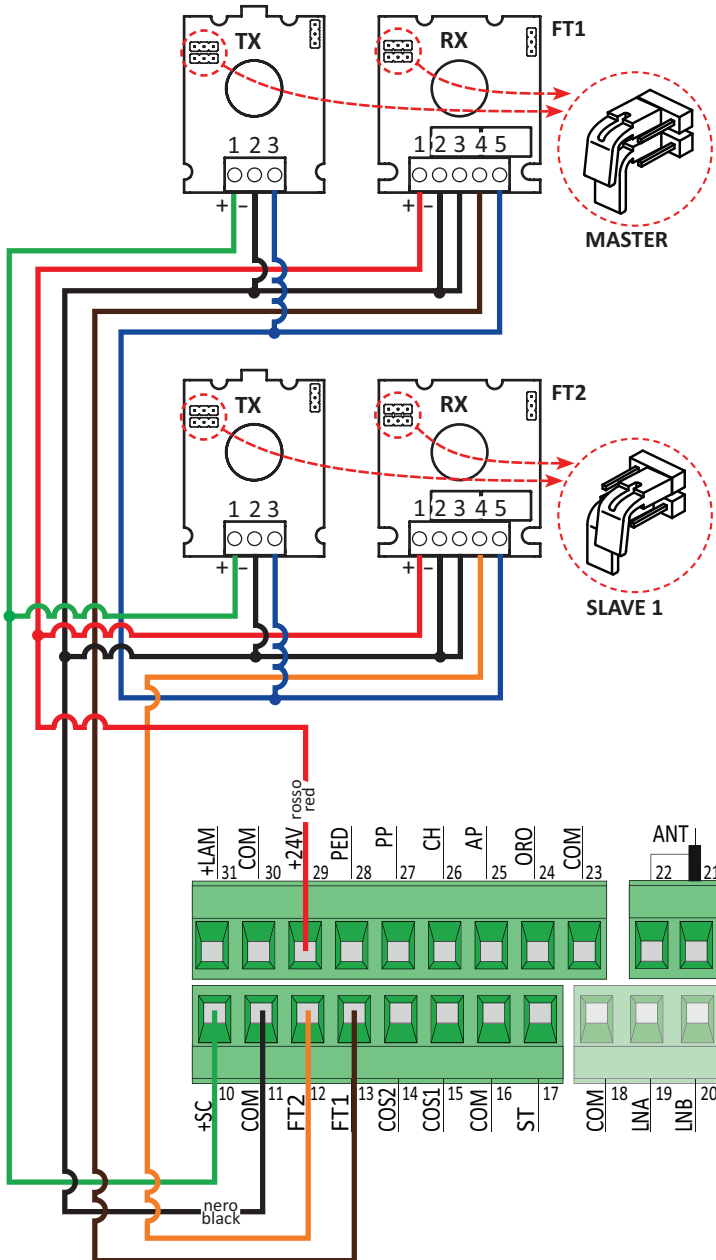

BATTERY SAVING (impostare · set AB 03)

BATTERY SAVING + TEST FOTOCELLULE · PHOTOCELLS TEST
(impostare · set AB 04)

 **USO RACCOMANDATO**
RECOMMENDED USE

R90/F4ES
G90/F4ES
T90/F4S

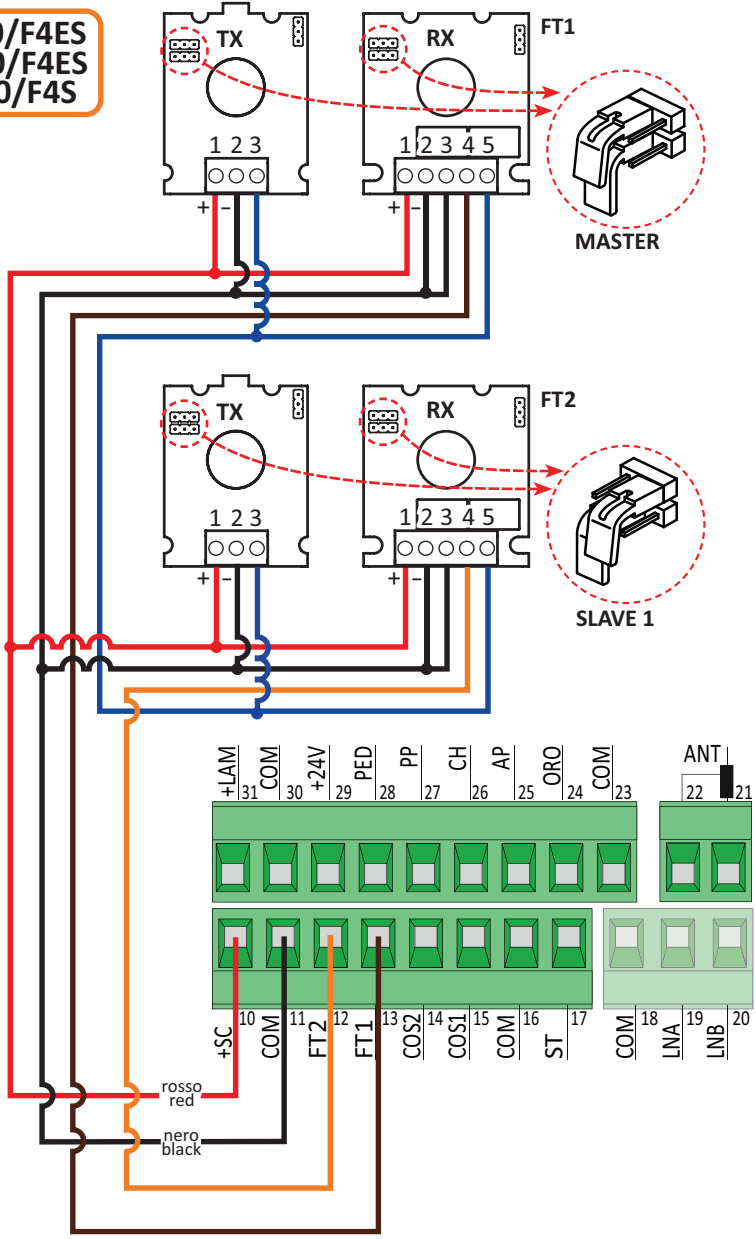

7

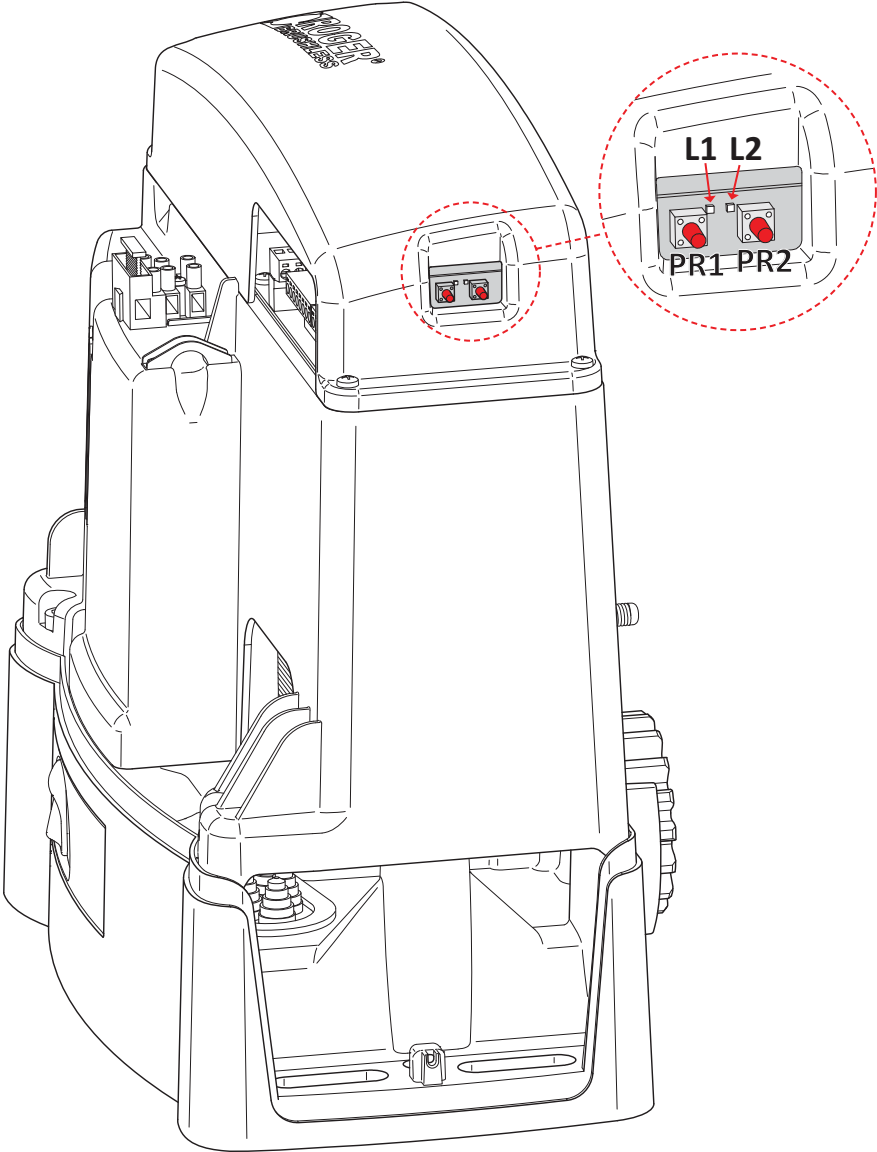

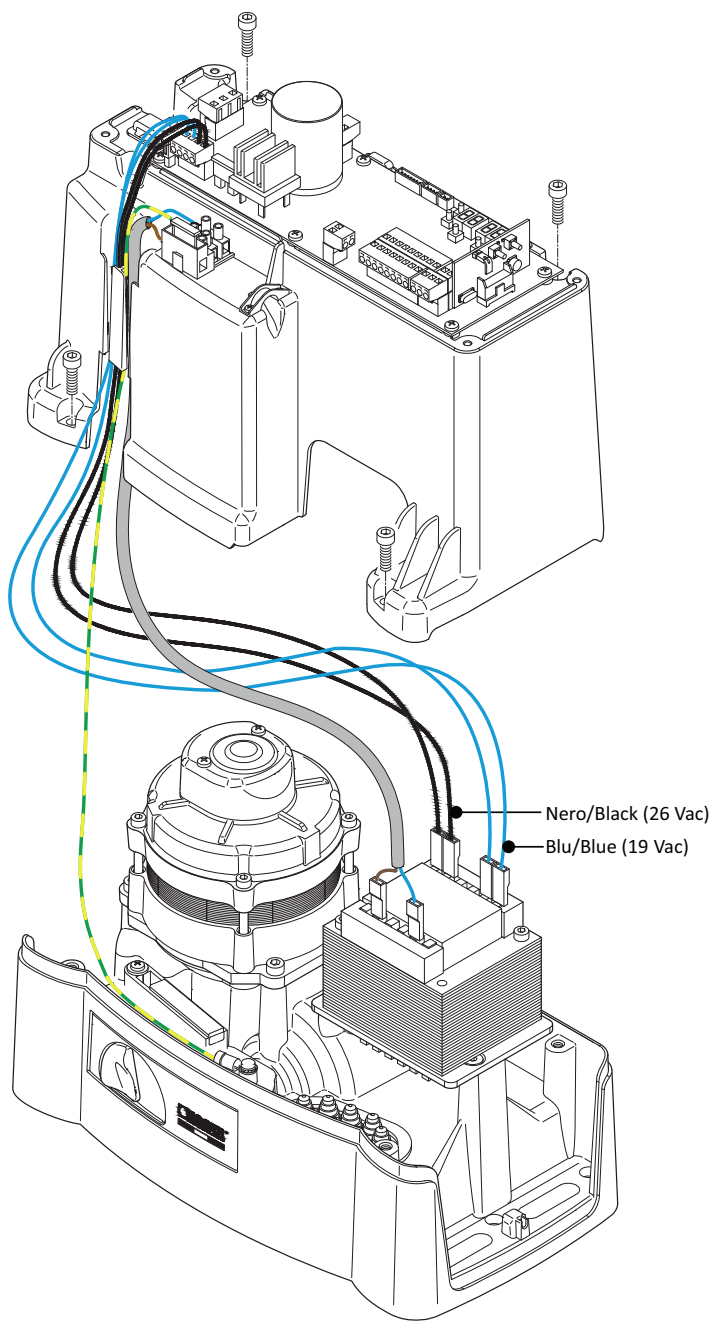

9

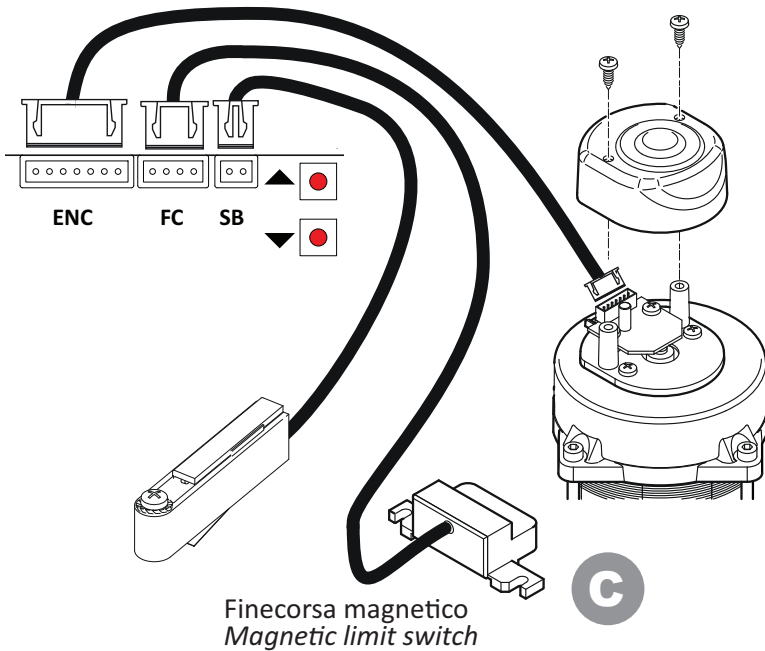
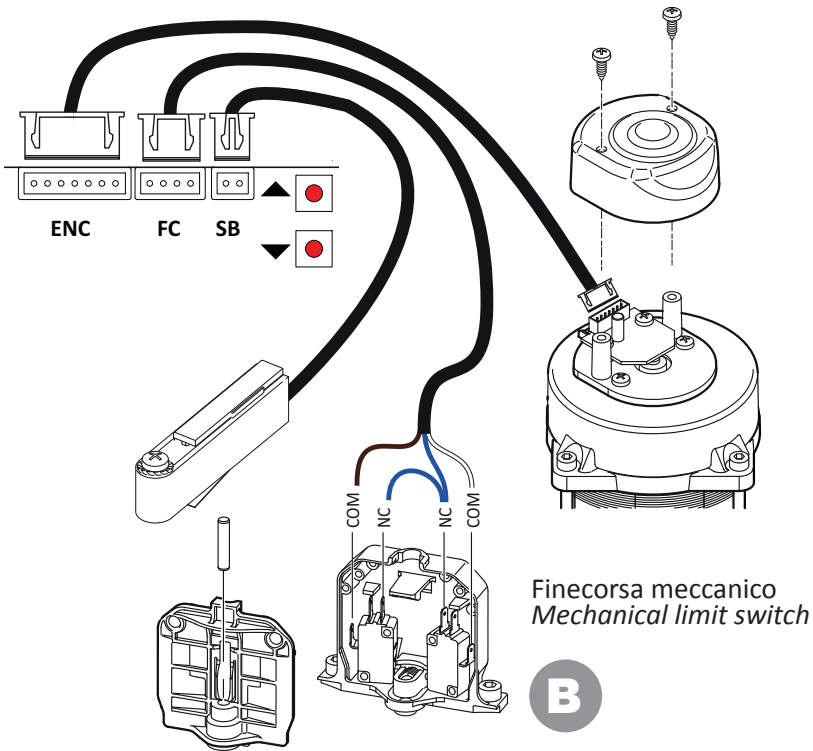

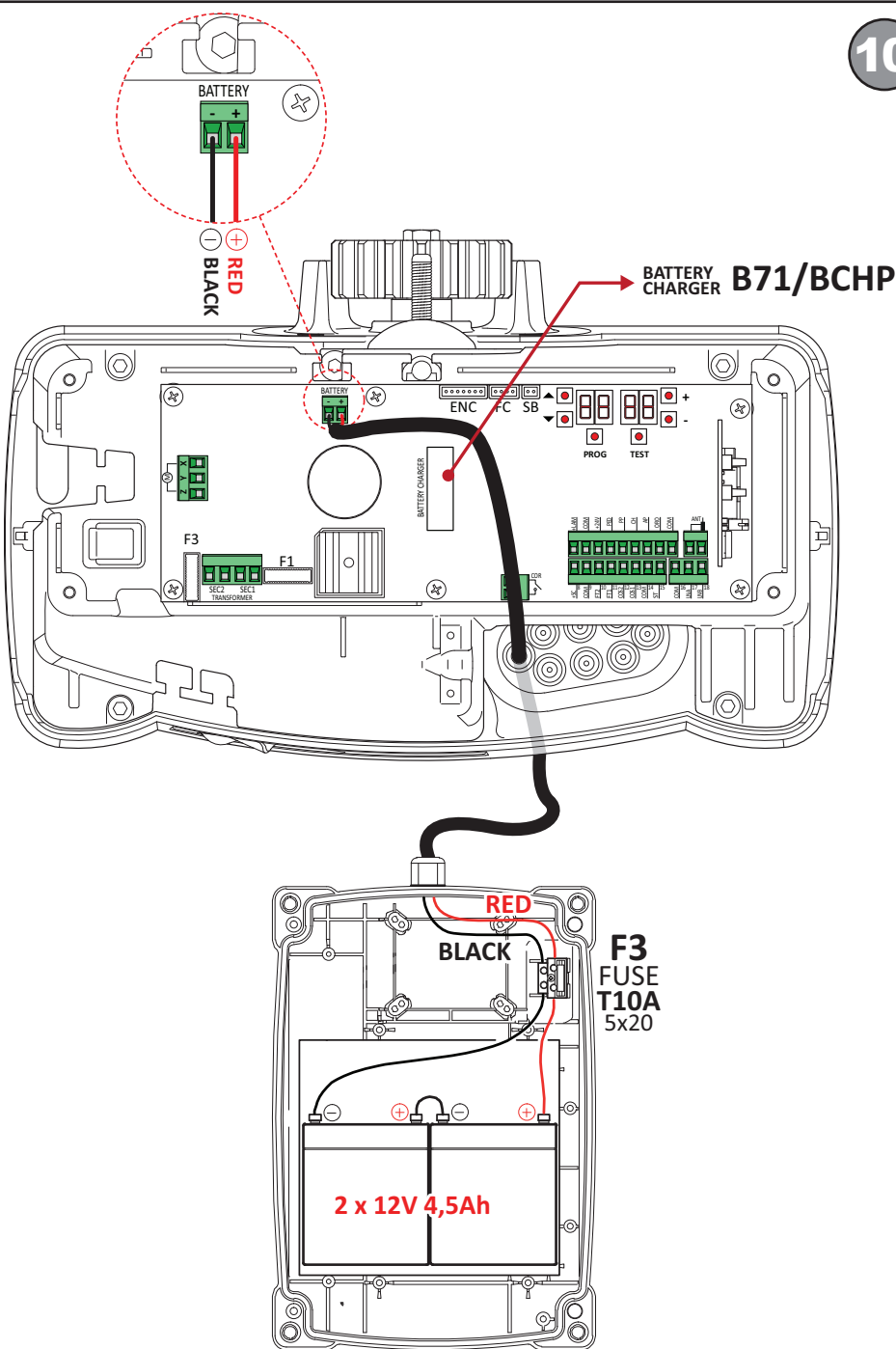

 **AGM Battery ONLY**

1 General safety precautions



Warning: incorrect installation may cause severe damage or injury.

Read the instructions carefully before installing the product.

This installation manual is intended for qualified personnel only.

ROGER TECHNOLOGY cannot be held responsible for any damage or injury due to improper use or any use other than the intended usage indicated in this manual.

Installation, electrical connections and adjustments must be performed by qualified personnel, in accordance with best practices and in compliance with applicable regulations.



Before installing the product, make sure it is in perfect condition.

A switch or an omnipolar cut-off switch with a contact opening of at least 3 mm must be installed on the mains power line.

Ensure that an adequate residual current circuit breaker and a suitable overcurrent cut-out are installed ahead of the electrical installation in accordance with best practices and in compliance with applicable legislation.

The European standards EN 12453 and EN 12455 define the minimum safety requirements for the operation of automatic doors and gates. In particular, these standards require the use of force limiting and safety devices (sensing ground plates, photocell barriers, operator detection function etc.) intended to detect persons or objects in the operating area and prevent collisions in all circumstances.

Where the safety of the installation is based on an impact force limiting system, it is necessary to verify that the characteristics and performance of the automation system are compliant with the requisites of applicable standards and legislation.

The installer is required to measure impact forces and programme the control unit with appropriate speed and torque values to ensure that the door or gate remains within the limits defined by the standards EN 12453 and EN 12455.

When requested, connect the automation to an effective earthing system that complies with current safety standards.

Disconnect the mains electrical power before performing any work. Also disconnect any buffer batteries used.

Only use original spare parts when repairing or replacing products.

The packaging materials (plastic, polystyrene, etc.) should not be discarded in the environment or left within reach of children, as they are a potential source of danger.

2 Product description

The **B70/1DCHP** 36 V digital control unit uses a high resolution encoder for the sensed power control of ROGER sliding gate leaf automation systems.

Ensure that the parameter A1 is set correctly. If this parameter is not set correctly, the automation system may not function properly.

We recommend using only ROGER TECHNOLOGY accessories and control and safety devices. Specifically, we recommend installing **R90/F4ES**, **G90/F4ES** or **T90/F4S** series photocells.

3 Technical characteristics of product

	BG30/1603 BG30/1604	BG30/2203 BG30/2204	BG30/1003/HS BG30/1004/HS	BG30/1404/R	BG30/1804/HS
MAINS POWER VOLTAGE	230 Vac \pm 10% 50 Hz (115 Vac \pm 10% 50/60 Hz) ⁽¹⁾				
MAXIMUM MAINS POWER ABSORPTION	390 W	470 W	590 W	540 W	650 W
FUSES	F1 = 20A (ATO257) motor power circuit protection F2 = 3A (ATO257) accessories power supply protection F3 = T2A (5x20 mm) primary transformer protection				
CONNECTABLE MOTORS	1				
MOTOR POWER SUPPLY	36 Vac, with self-protected inverter				
MOTOR TYPE	sinusoidal drive brushless (ROGER BRUSHLESS)				
MOTOR CONTROL TYPE	sensored field oriented control (FOC)				
RATED MOTOR POWER	85 W	100 W	140 W	120 W	160 W
MAXIMUM MOTOR POWER	350 W	420 W	530 W	480 W	590 W
MAXIMUM POWER, FLASHING LIGHT	25 W				
FLASHING LIGHT DUTY CYCLE	50%				
MAXIMUM POWER	100 W 230 Vac - 40 W 24 Vac/dc (potential free contact)				
GATE OPEN LIGHT POWER	3 W (24 Vdc)				
MAXIMUM ACCESSORY CURRENT ABSORPTION	20 W				
OPERATING TEMPERATURE					
PRODUCT DIMENSIONS	dimensions in mm 200x90x45 Weight: 0,244 kg				

⁽¹⁾ BG30/1603/115 - BG30/1604/115 - BG30/2203/115 - BG30/2204/115 - BG30/1003/HS/115 - BG30/1004/HS/115 - BG30/1404/R/115 - BG30/1804/HS/115

4 Description of connections

To access the control connection terminal board, remove the motor cover as shown in **figure 1**:

Figure 3 shows connection diagrams for connecting mains voltage to the motor control unit (**B70/1DCHP**).

Strip the insulation from the ends of the power cable wires which will be connected to the terminal (see **A, fig. 2**), and secure the cable with the cable clamp.

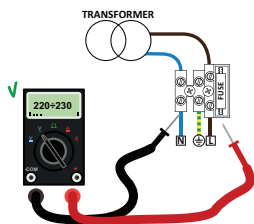

Measure the voltage on the primary mains power connection with a tester. For the brushless automation system to function correctly, the mains power voltage must be at least 230Vac (115 Vac) \pm 10%.

If the voltage measured is not as indicated above or is unstable, the automation system may NOT work correctly.

4.1 Electrical connections

CONNECTING CONTROL UNIT TO MAINS ELECTRICITY	L _{cab} le	
	1÷15 m	15÷30 m
Power supply 230 Vac ±10% (115 Vac ±10%)	3x1,5 mm ²	3x2,5 mm ²

CONNECTING CONTROL PANEL TO ACCESSORIES	L _{cab} le = 1÷20 m
Photocells - Receiver	4x0,5 mm ²
Photocells - Transmitter	2x0,5 mm ²
Keypad H85/TDS - H85/TTD (connecting to control panel to decoder board H85/DEC - H85/DEC2)	3x0,5 mm ²
Key selector R85/60	3x0,5 mm ²

CONNECTING CONTROL PANEL TO FLASHING LIGHT	L _{cab} le
Power supply 24 Vdc LED (25 W max, power consumption 50%)	2x1 mm ² (max 10 m)

CONNECTING CONTROL PANEL TO GATE OPEN INDICATOR	L _{cab} le
	1÷20 m
Power supply 24 Vdc (3 W max)	2x0,5 mm ²

CONNECTING CONTROL PANEL TO COURTESY LIGHT	L _{cab} le
	1÷20 m
Power supply 230 Vac (100 W power consumption)	2x1 mm ²

CONNECTING CONTROL PANEL TO ANTENNA	L _{cab} le
Cable type RG58	max 10 m

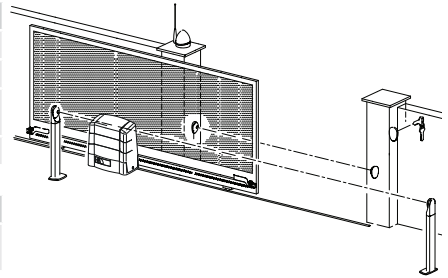

SUGGESTIONS: with existing installations, we recommend checking the cross section of the cables and that the cables themselves are in good condition.

	DESCRIPTION
	Mains power supply 230 Vac ±10% (115 Vac ±10%) connection. Fuse 5x20 T2A.
	Secondary transformer input for 26 V AC motor power (SEC1) and for 19 V power to logical control and peripheral devices (SEC2). N.B.: Ready wired in factory by ROGER TECHNOLOGY.
	Connection to ROGER brushless motor. N.B.: Ready wired in factory by ROGER TECHNOLOGY. Warning! If the motor wires become disconnected from the terminal board, after reconnecting correctly, the travel must be acquired again as described in chapter 8.
	Connection to B71/BCHP battery kit (see fig. 10). ⓘ See instructions for B71/BCHP for further information.

5 Function buttons and display

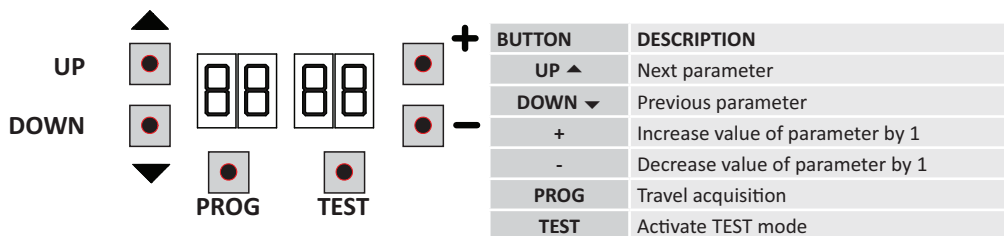

- Press the UP ▲ and/or DOWN ▼ buttons to view the parameter you intend to modify.
- Use the + and - buttons to modify the value of the parameter. The value starts to flash.
- Press and hold the + or - button to scroll quickly through values, to modify the parameter more quickly.
- To save the new value, wait a few seconds or move onto another parameter with the UP ▲ or DOWN ▼ button. The display flashes rapidly to indicate that the new value has been saved.
- Parameters can only be modified while the motor is not running. Parameters can be viewed at any time.

6 Switching on or commissioning

Power the control unit.

The firmware version of the control unit is displayed briefly.

Version installed r1.22.



Immediately afterwards, the display enters the commands and safety device status mode. See chapter 7.

7 Display function modes

- **Parameter display mode**

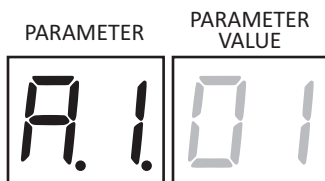

See chapter 10 for detailed descriptions of the parameters.

• Command and safety device status display mode

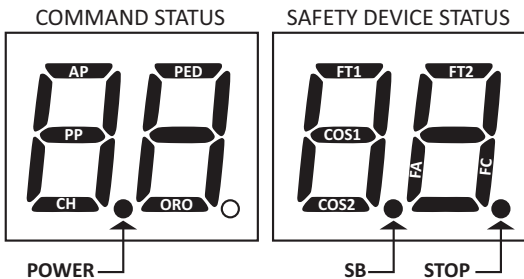

COMMAND STATUS:

The command status indicators on the display (segments AP = open, PP = step mode, CH = close, PED = partial opening, ORO = clock) are normally off. They illuminate when a command is received (e.g.: when a step mode command is received, the segment PP illuminates).

SAFETY DEVICE STATUS:

The safety device status indicators on the display (segments FT1/FT2 = photocells, COS1/COS2 = sensing edge, FA = gate open limit switch, FC = gate closed limit switch, SB = release handle open) are normally on. If an indicator is off, the relative device is in alarm state or is not connected.

The an indicator is flashing, the relative device has been disabled with a specific parameter.

• TEST mode

The TEST mode is used to test activation of the commands and safety devices with visual confirmation.

To activate the mode, press the TEST button with the automatic door system at rest. If the gate is moving, pressing TEST stops the gate. Pressing the button again enables TEST mode.

If the flashing light and the gate open indicator lamp illuminate for one second each time a control is used or a safety device is activated.

The command signal status is shown on the left hand side of the display for 5 seconds, ONLY when the respective command signal is active (AP, CH, PP, PE, OR). For example, if the gate open command is activated, the letters AP appear on the display.

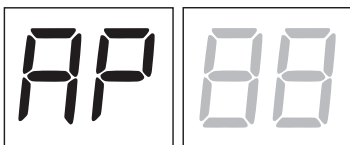

The status of the safety devices/inputs is shown on the right hand side of the display. The number of the terminal relative to the safety device in alarm state flashes.

When the gate is completely open or completely closed, *FR* or *FC* is shown on the display to indicate that the gate has reached the gate open limit switch *FR* or gate closed limit switch *FC*.

Example: STOP contact in alarm state.

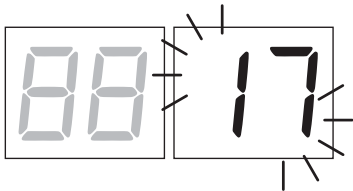

00	No safety device in alarm state, and no limit switch activated
5b (Sb)	Release handle or lock open.
17	STOP.
15	Sensing edge COS1.
14	Sensing edge COS2.
13	Photocell FT1.
12	Photocell FT2.
FE	Both limit switches
FA	Gate open limit switch
FC	Gate closed limit switch

NOTA: If one or more contacts are open, the gate will not open or close. This does not apply for the limit switch signal state, however, which is shown on the display but does not prevent normal operation of the gate.

If more than one safety device is in alarm state, once the problem relative to the first device is resolved, the alarm for the next device is displayed. Any further alarm states are also displayed with the same logic.

Press the TEST button again to exit test mode.

After 10 seconds with no user input, the display returns to command and safety device state display mode.

• **Standby mode**

This mode is activated after 30 minutes with no user input. The POWER LED flashes slowly.

Press UP ▲, DOWN ▼, +, - to reactivate the control unit.

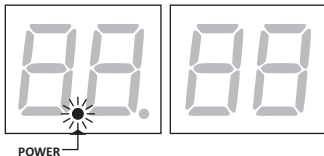

8 Travel acquisition

For the system to function correctly, the gate travel must be acquired by the control.

Before starting:

1. Select the position of the motor relative to the gate with the parameter τl . The default setting for this parameter is with the motor installed on the right hand side of the gate (seen from interior side).
2. Select the automation system model installed with the parameter AP .
3. Check that the operator present function is not enabled ($AP7$ $\square\square$).
4. Adjust the (mechanical or magnetic) limit switches so that, once triggered, the gate stops slightly before it reaches the mechanical stop.
5. Move the gate into the closed position.
6. Press **TEST** (see TEST mode in chapter 7) and check the command signal and safety device states. If any safety devices are not installed, jumper the relative contact or disable the device from the relative parameter ($S0$, $S1$, $S3$, $S4$, $\tau3$ and $\tau4$).

ACQUISITION PROCEDURE:

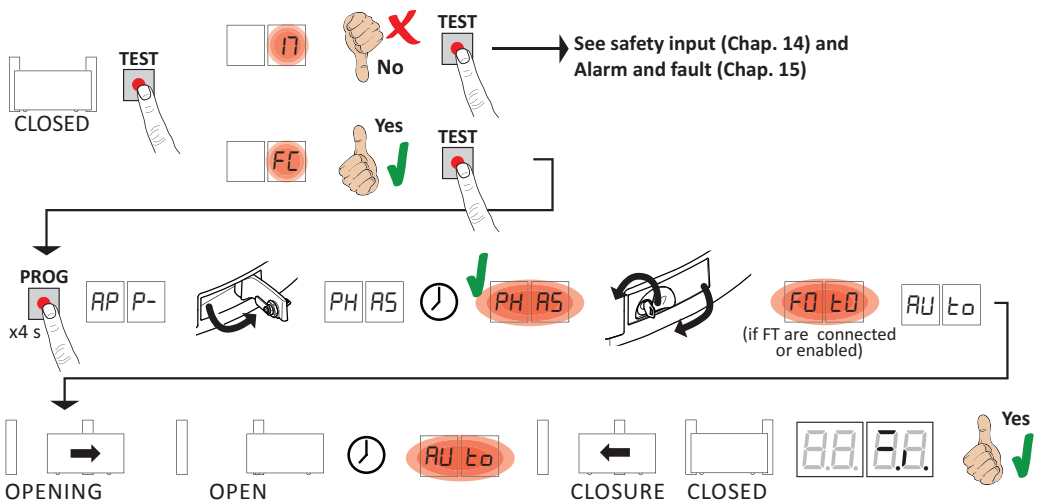

- Press and hold **PROG** for 4 seconds. $AP P-$ is shown on the display.
 - Open the release handle. The message $PH AS$ appears on the display after a few seconds. The controller unit launches a calibration procedure. The operating parameters of the motor are determined during calibration.
 - If the motor calibration procedure is successful, the message $PH AS$ flashes on the display.
 - Close the release handle. The acquisition procedure now starts.
 - $FO t0$ is shown on the display (only if parameters $S0$, $S1$, $S3$, $S4$ are not disabled). Keep away from the photocell beam within 5 s, to prevent interrupting the procedure.
 - $AU t0$ is shown on the display and the gate starts opening at low speed.
 - The gate stops briefly when it reaches the gate open limit switch. $AU t0$ flashes on the display.
 - The gate closes until it reaches the gate closed limit switch.
- If the acquisition procedure is completed successfully, the display enters the command and safety device state display mode.

If the following error messages are shown on the display, repeat the acquisition procedure:

- $no PH$: calibration procedure failed.
- $AP PE$: acquisition error. Press the **TEST** button to clear the error, and check the safety device in alarm state.
- $AP PL$: travel length error. Press the **TEST** button to clear the error, and check that gate is completely closed.

i For more information, see chapter 15 "Alarms and faults".



9 Parameter's index

PARAM.	FACTORY VALUE	DESCRIPTION	PAGE
A1	01	Selecting automation system model	50
A1	03 	Selecting automation BG30/1000/HS	50
A1	04 	Selecting automation BG30/1400/R	50
A2	00	Automatic closure after pause time (from gate completely open)	50
A3	00	Automatic gate closing after mains power outage	50
A4	00	Selecting step mode control function (PP)	51
A5	00	Pre-flashing	51
A6	00	Condominium function for partial open command (PED)	51
A7	00	Enabling operator present function.	51
A8	00	Gate open indicator / photocell test function and "battery saving"	51
11	04	Setting deceleration during opening (and closing for BG30/1600 - BG30/2200)	51
12	04  	Setting deceleration during closing (BG30/1000/HS, BG30/1400/R and BG30/1800/HS only)	51
13	02	Setting gate open limit switch constant speed approach distance	51
14	02	Setting gate closed limit switch constant speed approach distance	51
15	50	Partial opening adjustment (%)	51
21	30	Setting automatic closing time	51
27	03	Setting reverse time after activation of sensing edge or obstacle detection (crush prevention).	52
30	05	Setting motor torque	52
31	15	Setting obstacle impact force sensitivity	52
33	04	Setting start acceleration during opening (and closing for BG30/1600 - BG30/2200)	52
34	04  	Setting start acceleration during closing (BG30/1000/HS, BG30/1400/R and BG30/1800/HS only)	52
36	00	Enabling maximum torque boost at start of manoeuvre	52
37	01	Setting motor torque during position recovery	52
40	08	Setting opening speed (and closing for BG30/1600 - BG30/2200)	53
41	08  	Setting closing speed (BG30/1000/HS, BG30/1400/R and BG30/1800/HS only)	53
42	03	Setting end of manoeuvre constant approach speed	53
49	01	Setting number of automatic closure attempts after activation of sensing edge or obstacle detection (crush protection)	53
50	00	Setting photocell mode during gate opening (FT1)	53
51	02	Setting photocell mode during gate closing (FT1)	53
52	01	Photocell (FT1) mode with gate closed	53
53	00	Setting photocell mode during gate opening (FT2)	53
54	00	Setting photocell mode during gate closing (FT2)	54
55	01	Photocell (FT2) mode with gate closed	54
56	00	Enable close command 6 s after activation of photocell (FT1-FT2)	54
65	05	Setting motor stop distance	54
71	01	Selecting installation position of motor relative to gate (seen from interior side)	54

PARAM.	FACTORY VALUE	DESCRIPTION	PAGE
73	00	Configuring sensing edge COS1	54
74	00	Configuring sensing edge COS2	54
76	00	Configuring radio channel 1 (PR1)	55
77	01	Configuring radio channel 2 (PR2)	55
78	00	Configuring flashing light frequency	55
79	60	Selecting courtesy light mode	55
80	00	Clock contact configuration.	55
81	00	Enable safeguarded gate closure/opening.	56
82	03	Setting safeguarded closure/opening activation time	56
90	00	Restoring factory default values	56
r0	01	HW version.	56
r1	23	Year of manufacture	56
r2	45	Week of manufacture	56
r3	67	Serial number	56
r4	89		56
r5	01	FW version	56
r6	23		56
a7	01	View manoeuvre counter	57
a0	23		57
a1	45		57
h0	01	View manoeuvre hour counter	57
h1	23		57
d0	01	View control unit days on counter	57
d1	23		57
P1	00	Password	57
P2	00		57
P3	00		57
P4	00		57
CP	00	Changing password	57

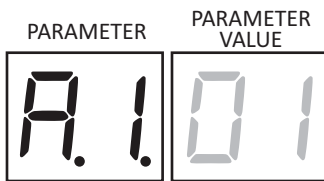
10 Parameter menu



A101	Selecting automation system model WARNING! If this parameter is not set correctly, the automation system may not function properly. N.B.: in the event of a reset to restore the default parameters, this parameter must be set again manually.
01	BG30/1600 - IRREVERSIBLE motor for gate leaves up to 1600 Kg.
02	BG30/2200 - IRREVERSIBLE motor for gate leaves up to 2200 Kg.
03	BG30/1000/HS  - High Speed IRREVERSIBLE motor for gate leaves up to 1000 Kg (see chapter 11 "Special Parameters for High Speed Motor").
04	BG30/1400/R  - REVERSIBLE motor for gate leaves up to 1400 Kg (see chapter 12 "Special Parameters for REVERSIBLE Motor").
05	BG30/1800/HS  - High Speed IRREVERSIBLE motor for gate leaves up to 1800 Kg (see chapter 11 "Special Parameters for High Speed Motor").
A200	Automatic closure after pause time (from gate completely open)
00	Disabled.
01-15	From 1 to 15 of gate closure attempts after photocell is triggered. Once the number of attempts set is reached, the gate remains open.
99	The gate tries to close indefinitely.
A300	Automatic gate closing after mains power outage
00	Disabled. The gate does not close automatically when mains power is restored.
01	Enabled. If the gate is NOT completely open, when mains power is restored, the gate closes after a 5 second warning signalled with the flashing light (independently of the value set with the parameter A5). The gate closes in "position recovery" mode (see chapter 17).
A400	Selecting step mode control function (PP)
00	Open-stop-close-stop-open-stop-close...
01	Condominium function: the gate opens and closes after the set automatic closing time. The automatic closing timer restarts if a new step mode command is received. Step mode commands are ignored while the gate is opening. This allows the gate to open completely and prevents the gate from closing when not required. If automatic closing is disabled (A2 00), the condominium function automatically attempts a closing manoeuvre A2 01.
02	Condominium function: the gate opens and closes after the set automatic closing time. The automatic closing timer does NOT restart if a new step mode command is received. Step mode commands are ignored while the gate is opening. This allows the gate to open completely and prevents the gate from closing when not required. If automatic closing is disabled (A2 00), the condominium function automatically attempts a closing manoeuvre A2 01.
03	Open-close-open-close.
04	Open-close-stop-open.

A5 00	Pre-flashing
00	Disabled. The flashing light is activated during opening and closing manoeuvres.
01-10	Flashing warning signal for 1 to 10 seconds prior to every manoeuvre.
99	5 second flashing warning signal prior to closing manoeuvre.
A6 00	Condominium function for partial open command (PED)
00	Disabled. The gate opens partially in step mode: open-stop-close-stop-open...
01	Enabled. Partial commands are ignored during gate opening.
A7 00	Enabling operator present function.
00	Disabled.
01	Enabled. The open (AP) or close (CH) button must be pressed continuously to operate the gate. The gate stops when the button is released.
A8 00	Gate open indicator / photocell test function and "battery saving"
00	The indicator is off when the gate is closed, and steadily lit during manoeuvres and when the gate is open.
01	The indicator flashes slowly during opening manoeuvres, and is lit steadily when the gate is completely open. It flashes quickly during closing manoeuvres. If the gate is stopped in an intermediate position, the lamp extinguishes twice every 15 seconds.
02	Set 02 if the output SC is used for the photocell test. See fig. 5.
03	Set to 03 if the output SC is used for the "battery saving" function. See fig. 6.
04	When the gate is completely open or closed, the controller unit deactivates any accessories connected to terminal SC to reduce battery consumption.
04	Set to 04 if the output SC is used for the "battery saving" function and photocell test function. See fig. 6.
11 04	Setting deceleration during opening and closing
12 04	See chapters 11 and 12
01-05	01= the gate decelerates near the limit switch ... 05= the gate decelerates long before the limit switch.
13 02	Setting gate open limit switch constant speed approach distance
	N.B.: the manoeuvre speed is set with parameter 42. After decelerating, the gate completes the distance to the limit switch at constant speed.
14 02	Setting gate closed limit switch constant speed approach distance
	N.B.: the manoeuvre speed is set with parameter 42. After decelerating, the gate completes the distance to the limit switch at constant speed.
01-40	01= last 3 cm; 02= last 6 cm; ... 40= last 120 cm. Approximate example: 100 cm distance = value 35.
15 50	Partial opening adjustment (%)
	N.B.: This parameter is set to 50% (half of total gate travel) by default.
10-99	From 10% to 99% of total gate travel.
21 30	Setting automatic closing time
	The timer starts from the gate open state and continues for the set time. Once the set time is reached, the gate closes automatically. The timer count restarts if a photocell is triggered.
00-90	Pause time settable from 00 to 90 s.
92-99	Pause time settable from 2 to 9 min.

27 03	<p>Setting reverse time after activation of sensing edge or obstacle detection (crush prevention).</p> <p>This sets the reverse manoeuvre time after activation of the sensing edge or the obstacle detection system. The gate comes to a stop after reversal dues to activation of the sensing edge or obstacle detection system at the end of manoeuvre deceleration speed. As a result, the effective reversal manoeuvre time is slightly longer than the set time.</p>
00-60	From 0 to 60 s.
30 05	<p>Setting motor torque</p> <p>Increasing or decreasing the value of the parameter increases or decreases motor torque and, as a result, adjusts obstacle detection sensitivity.</p> <p>Use values below 03 ONLY for particularly lightweight installations not exposed to severe weather conditions (strong winds or very cold temperatures).</p>
01-09	01= -35%; 02= -25%; 03= -16%; 04= -8% (reduced motor torque = increased sensitivity). 05= default motor torque setting. 06= +8%; 07= +16%; 08= +25%; 09= +35% (increased motor torque = reduced sensitivity).
31 15	<p>Setting obstacle impact force sensitivity</p> <p>If the reaction time to obstacle impact force is too long, reduce the value of the parameter. If the impact force exerted on obstacles is too high, reduce the value of parameter 30.</p>
01-10	Low motor torque: 01 = minimum obstacle impact force ... 10 = maximum obstacle impact force N.B.: only use these settings if the medium motor torque values are not suitable for the installation.
11-16	Medium motor torque. Recommended setting for adjusting force settings correctly. 11 = minimum obstacle impact force ... 16 = maximum obstacle impact force.
17	70% of maximum motor torque, 1 s of reaction time. Sensing edge is compulsory.
18	80% of maximum motor torque, 2 s of reaction time. Sensing edge is compulsory.
19	Maximum motor torque, 3 s of reaction time. Sensing edge is compulsory.
20	Maximum motor torque, 5 s of reaction time. Sensing edge is compulsory.
33 04	Setting start acceleration during opening and closing
34 04	See chapters 11 and 12
01-05	01= the gate accelerates rapidly at start of manoeuvre ... 05= the gate accelerates slowly and progressively at start of manoeuvre.
36 00	<p>Enabling maximum torque boost at start of manoeuvre</p> <p>If this parameter is enabled, each time the motor starts a manoeuvre, maximum torque is produced for a maximum of 5 seconds, or for the time necessary for the gate to open by approximately 65 cm.</p> <p>N.B.: in the case of BG30/1000/HS and BG30/1400/R motors, a motor boost mode is implemented for 2 seconds after each gate start, regardless of the setting of parameter 35.</p>
00	Disabled.
01	Enabled at start of opening manoeuvre only (including position recovery). The motor starting current function is only enabled for closing manoeuvres if the gate position is known and the gate is over to 2 metres from the completely closed position.
02	Enabled for all starts (including position recovery).
37 01	<p>Setting motor torque during position recovery</p> <p>Adjust motor torque with parameter 37 if, during position recovery, the values set with parameters 30 and 31 are insufficient to allow the gate to complete the manoeuvre.</p> <p>If position recovery is not completed, normal gate operation will not be resumed.</p>
00	The response of the obstacle detection system depends solely on the values set for parameters 30 and 31.
01	The response of the obstacle detection system depends on the values set for parameters 30 and 31 and on the maximum current value stored during travel acquisition.
02	The response of the obstacle detection system is a 70% reduction in maximum torque for a period of 1 s.
03	The response of the obstacle detection system is a 80% reduction in maximum torque for a period of 2 s.
04	The response of the obstacle detection system is a 100% reduction in maximum torque for a period of 3 s.
05	The response of the obstacle detection system is a 100% reduction in maximum torque for a period of 5 s.

40 08	Setting opening and closing speed N.B.: the speed setting range for the specific motor installed is automatically subdivided into 10 equal segments.
41 08	See chapters 11 and 12
01-10	01= 6 m/min ... 10= maximum speed.
42 03	Setting end of manoeuvre constant approach speed Once deceleration is complete, the gate continues to the limit switch at constant speed. The distance is set with the parameters 13 and 14.
01-05	01= 2 m/min; 02= 2,5 m/min; 03= 3 m/min; 04= 3,5 m/min; 05= 4 m/min.
49 01	Setting number of automatic closure attempts after activation of sensing edge or obstacle detection (crush protection)
00	No automatic closure attempts.
01-03	From 1 to 3 automatic closure attempts. We recommend setting a value equal to or lower than the value set for parameter A2. Automatic closure is only performed if the gate is completely open.
50 00	Setting photocell mode during gate opening (FT1)
00	DISABLED. Photocell is not active or not installed.
01	STOP. The gate stops and remains stationary until the next command is received.
02	IMMEDIATE REVERSE. The gate reverses immediately if the photocell is activated during gate opening.
03	TEMPORARY STOP. The gate stops as long as the photocell is obstructed. The gate resumed opening when the photocell is cleared.
04	DELAYED REVERSE. The gate stops if the photocell is obstructed. The gate closes when the photocell is cleared.
51 02	Setting photocell mode during gate closing (FT1)
00	DISABLED. Photocell is not active or not installed.
01	STOP. The gate stops and remains stationary until the next command is received.
02	IMMEDIATE REVERSE. The gate reverses immediately if the photocell is activated during gate closure.
03	TEMPORARY STOP. The gate stops as long as the photocell is obstructed. The gate resumed closing when the photocell is cleared.
04	DELAYED REVERSE. The gate stops if the photocell is obstructed. The gate opens when the photocell is cleared.
52 01	Photocell (FT1) mode with gate closed
00	If the photocell is obstructed, the gate cannot open.
01	The gate opens when an open command is received, even if the photocell is obstructed.
02	The photocell sends the gate open command when obstructed.
53 00	Setting photocell mode during gate opening (FT2)
00	DISABLED. Photocell is not active or not installed.
01	STOP. The gate stops and remains stationary until the next command is received.
02	IMMEDIATE REVERSE. The gate reverses immediately if the photocell is activated during gate opening.
03	TEMPORARY STOP. The gate stops as long as the photocell is obstructed. The gate resumed opening when the photocell is cleared.
04	DELAYED REVERSE. The gate stops if the photocell is obstructed. The gate closes when the photocell is cleared.

54 00	Setting photocell mode during gate closing (FT2)
00	DISABLED. Photocell is not active or not installed.
01	STOP. The gate stops and remains stationary until the next command is received.
02	IMMEDIATE REVERSE. The gate reverses immediately if the photocell is activated during gate closure.
03	TEMPORARY STOP. The gate stops as long as the photocell is obstructed. The gate resumed closing when the photocell is cleared.
04	DELAYED REVERSE. The gate stops if the photocell is obstructed. The gate opens when the photocell is cleared.

55 01	Photocell (FT2) mode with gate closed
00	If the photocell is obstructed, the gate cannot open.
01	The gate opens when an open command is received, even if the photocell is obstructed.
02	The photocell sends the gate open command when obstructed.

56 00	Enable close command 6 s after activation of photocell (FT1-FT2)
This parameter is not visible if AB 03 or AB 04 is set.	
00	Disabled.
01	Enabled. When the photocell barrier FT1 is crossed, a close command is sent 6 seconds later.
02	Enabled. When the photocell barrier FT2 is crossed, a close command is sent 6 seconds later.

65 05	Setting motor stop distance
01-05	01= faster deceleration/shorter stop distance ... 05= slower deceleration/longer stop distance.

71 01	Selecting installation position of motor relative to gate (seen from interior side)
N.B.: The error message <i>dRtR</i> is shown on the display whenever this parameter is modified. Press PRG button and repeat the travel acquisition procedure.	
00	Motor installed on left.
01	Motor installed on right.

73 00	Configuring sensing edge COS1
00	Sensing edge NOT INSTALLED.
01	NC contact (normally closed). The gate reverses only when opening.
02	Contact with 8k2 resistor. The gate reverses only when opening.
03	NC contact (normally closed). The gate always reverses.
04	Contact with 8k2 resistor. The gate always reverses.

74 00	Configuring sensing edge COS2
00	Sensing edge NOT INSTALLED.
01	NC contact (normally closed). The gate reverses only when closing.
02	Contact with 8k2 resistor. The gate reverses only when closing.
03	NC contact (normally closed). The gate always reverses.
04	Contact with 8k2 resistor. The gate always reverses.

76 00	Configuring radio channel 1 (PR1) N.B.: With ROGER TECHNOLOGY plug-in radio receiver board.
77 01	Configuring radio channel 2 (PR2) N.B.: With ROGER TECHNOLOGY plug-in radio receiver board.
00	STEP MODE.
01	PARTIAL OPENING
02	OPENING
03	CLOSING.
04	STOP.
05	Courtesy light. The output COR is managed from the remote control. The light remains lit as long as the remote control is active. The parameter 79 is ignored.
06	Courtesy light in step mode (PP). The output COR is managed from the remote control. The remote control turns the courtesy light on and off. The parameter 79 is ignored.
07	STEP MODE with confirmation for safety. ⁽¹⁾
08	PARTIAL OPENING with confirmation for safety. ⁽¹⁾
09	OPENING with confirmation for safety. ⁽¹⁾
10	CLOSURE with confirmation for safety. ⁽¹⁾

⁽¹⁾ To prevent gate manoeuvres caused by accidentally pressing a remote control button, confirmation is required to enable the command.

Example: parameters 76 07 and 77 01 set:

- Pressing the CHA button on the remote control selects the step mode function, which must be confirmed within 2 seconds by pressing CHB on the remote control. Press CHB to activate partial opening.

78 00	Configuring flashing light frequency
00	The frequency is set electronically from the flashing light unit.
01	Slow flash.
02	Light flashes slowly when gate opens, rapidly when gate closes.

79 60	Selecting courtesy light mode
00	Disabled.
01	PULSE. The courtesy light illuminates briefly at the start of each manoeuvre.
02	ACTIVE. The light remains lit for the entire duration of the manoeuvre.
03-90	From 3 to 90 s. The light remains lit for the time period set after the manoeuvre is completed.
92-99	From 2 to 9 minutes. The light remains lit for the time period set after the manoeuvre is completed.

80 00	Clock contact configuration. When the clock function is active, the gate opens and remains open. At the end of the programmed time set with the external device (clock), the gate closes.
00	When the clock function is active, the gate opens and remains open. Any command signal received is ignored.
01	When the clock function is active, the gate opens and remains open. Any command signal received is accepted. When the gate returns to the completely open position, the clock function is reactivated.

B100	Enable safeguarded gate closure/opening. Enabling this parameter ensures that the gate is not left open due to an incorrect and/or accidental command. This function is <u>NOT</u> enabled if: <ul style="list-style-type: none"> the gate receives a STOP command; the sensing edge is activated; the number of closure attempts set by parameter <i>B2</i> has been reached; the acquired position is lost (perform position recovery, see chapter 18).
00	Disabled. The parameter <i>B2</i> is not displayed.
01	Enabled. After a period of time set with parameter <i>B2</i> , the control unit signals a 5 second warning with the flashing light, regardless of the parameter <i>A5</i> , and then closes the gate.
02	Enabled. If the gate is closed as a result of a step mode command, after a period of time set with parameter <i>B2</i> , the control unit signals a 5 second warning with the flashing light (regardless of the parameter <i>A5</i>), and then the gate closes. If the gate is stopped by the obstacle detection system during a closure manoeuvre, the gate closes after a period of time set with parameter <i>B2</i> . If the gate is stopped by the obstacle detection system during an opening manoeuvre, the gate closes after a period of time set with parameter <i>B2</i> .

B203	Setting safeguarded closure/opening activation time N.B.: this parameter is not visible if the value of parameter <i>B1</i> = 00.
02-90	Wait time settable from 2 to 90 s.
92-99	Wait time settable from 2 to 9 min.

9000	Restoring factory default values NOTE This procedure is only possible if NO data protection password is set.
-------------	---

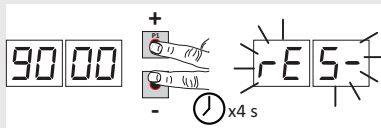

Warning! Restoring default settings cancels all settings made previously except for parameter *A1* : after restore, check that all parameters are suitable for the installation.

The default factory settings may also be restored using the + (PLUS) and/or - (MINUS) buttons as follows:

- Turn off the power.
- Press and hold the + (PLUS) and - (MINUS) button until the unit switches on.
- The display flashes after 4 s rE5-.
- The default factory settings have now been restored.

	Identification number The identification number consists of the values of the parameters from <i>n0</i> to <i>n6</i> . N.B.: The values shown in the table are indicative only.
--	---

<i>n001</i>	HW version.	Example: 01 23 45 67 89 01 23
<i>n123</i>	Year of manufacture.	
<i>n245</i>	Week of manufacture.	
<i>n367</i>		
<i>n489</i>	Serial number.	
<i>n501</i>		
<i>n623</i>	FW version.	

View manoeuvre counter

The number consists of the values of the parameters from $o\bar{n}$ to $o\bar{l}$ multiplied by 100.

N.B.: The values shown in the table are indicative only.

$o\bar{n} 01$

$o\bar{o} 23$

$o\bar{l} 45$

Manoeuvres performed.

Example: $o\bar{l} 23 45 \times 100 = 1.234.500$ manoeuvres.

View manoeuvre hour counter

The number consists of the values of the parameters from $h\bar{o}$ to $h\bar{l}$.

N.B.: The values shown in the table are indicative only.

$h\bar{o} 01$

$h\bar{l} 23$

Manoeuvre hours.

Example: $h\bar{l} 23 = 123$ hours.

View control unit days on counter

The number consists of the values of the parameters from $d\bar{o}$ to $d\bar{l}$.

N.B.: The values shown in the table are indicative only.

$d\bar{o} 01$

$d\bar{l} 23$

Days with unit switched on.

Example: $d\bar{l} 23 = 123$ days.

Password

Setting a password prevents unauthorised persons from accessing the settings.

With password protection active ($CP=01$), parameters may be viewed, but the values CANNOT be modified.

Only a single password is used to control access to the gate automation system.

WARNING: Contact the Technical Support Service if you lose your password.

$P1 00$

$P2 00$

$P3 00$

$P4 00$

Password activation procedure:

- Enter the desired values for parameters $P1$, $P2$, $P3$ and $P4$.
- Use the UP ▲ and/or DOWN ▼ buttons to view the parameter CP .
- Press and hold the + and - buttons for 4 seconds.
- The display flashes to confirm that the password has been saved.
- Switch the control unit off and on again. Check that password protection is activated ($CP=01$).

Temporary unlock procedure:

- Enter the password.
- Check that $CP=00$.

Password cancellation procedure:

- Enter the password ($CP=00$).
- Save the values $P1$, $P2$, $P3$, $P4 = 00$
- Use the UP ▲ and/or DOWN ▼ buttons to view the parameter CP .
- Press and hold the + and - buttons for 4 seconds.
- The display flashes to confirm that the password has been cancelled (the values $P1 00$, $P2 00$, $P3 00$ and $P4 00$ indicate that no password is set).
- Switch the control unit off and on again.

$CP 00$

Changing password

00

Protection deactivated.

01

Protection activated.

11 Special parameters for BG30/1000/HS - BG30/1800/HS series



The BG30/HS series (High Speed) is a family of digital brushless high speed sliding motor units for sliding gates weighing up to 1000 kg or 1800 kg and dedicated exclusively to residential applications. High Speed technology makes it possible for the automation system to operate 100% faster than a conventional system, and allows independent management of speed, acceleration, deceleration and the safety devices used in the system.

Note: As the mechanics of the gate is unknown, to guarantee the maximum safety of the installation, we recommended to use sensitive edges.

The additional parameters for enabling High Speed technology are indicated as follows.

1103	<p>Selecting automation system model</p> <p>This parameter is factory configured by ROGER TECHNOLOGY.</p> <p>WARNING! The parameter is already configured by default to enable use of the of motor in high speed mode. If this parameter is modified, all the specific motor functions relative to high speed mode will no longer be available.</p> <p>The automation system will no longer function effectively and it will not be possible to diagnose faults.</p> <p>N.B.: in the event of a reset to restore the default parameters, this parameter must be set again manually.</p>
01	BG30/1600 - IRREVERSIBLE motor for gate leaves up to 1600 Kg.
02	BG30/2200 - IRREVERSIBLE motor for gate leaves up to 2200 Kg.
03	BG30/1000/HS - High Speed IRREVERSIBLE motor for gate leaves up to 1000 Kg
04	BG30/1400/R - REVERSIBLE motor for gate leaves up to 1400 Kg .
05	BG30/1800/HS - High Speed IRREVERSIBLE motor for gate leaves up to 1800 Kg
1104	Setting deceleration during opening
1204	Setting deceleration during closing
01-05	01= the gate decelerates near the limit switch ... 05= the gate decelerates long before the limit switch.
3304	Setting start acceleration during opening
3404	Setting start acceleration during closing
01-05	01= the gate accelerates rapidly at start of manoeuvre ... 05= the gate accelerates slowly and progressively at start of manoeuvre.
4008	<p>Setting opening speed</p> <p>N.B.: the speed setting range for the specific motor installed is automatically subdivided into 10 equal segments.</p>
4108	<p>Setting closure speed</p> <p>N.B.: the speed setting range for the specific motor installed is automatically subdivided into 10 equal segments.</p>
01-05	01= 6 m/min ... 10= maximum speed.



N.B.: to set the constant speed deceleration space, see parameters 13 and 14 on Chapter 10.

12 Special parameters for BG30/1400/R series



The BG30/R series (REVERSIBLE) is a family of digital brushless motor units for sliding gates weighing up to 1400 kg and dedicated exclusively to residential and industrial applications.

REVERSIBLE technology makes it possible to open and close the gate without releasing the motor even in the event of power failure. The control unit allows independent management of speed, acceleration, deceleration and the safety devices used in the system.

During normal operation (including operation under battery power), the control unit applies a sufficient braking force to impede manual movement of the gate.

As a result, prolonged operation may drain the battery when operating under battery power.

If the braking force applied is not sufficient to impede manual movement of the gate and a gate movement of more than 3 cm is detected, the control unit initiates a position recovery procedure (see chapter 18).

The additional parameters for enabling REVERSIBLE technology are indicated as follows.

R104	Selecting automation system model This parameter is factory configured by ROGER TECHNOLOGY. WARNING! The parameter is already configured by default to enable use of the of motor REVERSIBLE mode. If this parameter is modified, all the specific motor functions relative to REVERSIBLE mode will no longer be available. The automation system will no longer function effectively and it will not be possible to diagnose faults. N.B.: in the event of a reset to restore the default parameters, this parameter must be set again manually.
01	BG30/1600 - IRREVERSIBLE motor for gate leaves up to 1600 Kg.
02	BG30/2200 - IRREVERSIBLE motor for gate leaves up to 2200 Kg.
03	BG30/1000/HS - High Speed IRREVERSIBLE motor for gate leaves up to 1000 Kg.
04	BG30/1400/R - REVERSIBLE motor for gate leaves up to 1400 Kg .
05	BG30/1800/HS - High Speed IRREVERSIBLE motor for gate leaves up to 1800 Kg.
1104	Setting deceleration during opening
1204	Setting deceleration during closing
01-05	01= the gate decelerates near the limit switch ... 05= the gate decelerates long before the limit switch.
3304	Setting start acceleration during opening
3404	Setting start acceleration during closing
01-05	01= the gate accelerates rapidly at start of manoeuvre ... 05= the gate accelerates slowly and progressively at start of manoeuvre.
4008	Setting opening speed N.B.: the speed setting range for the specific motor installed is automatically subdivided into 10 equal segments.
4108	Setting closure speed N.B.: the speed setting range for the specific motor installed is automatically subdivided into 10 equal segments.
01-10	01= 6 m/min ... 10= maximum speed.



N.B.: to set the constant speed deceleration space, see parameters 13 and 14 on Chapter 10.





13 Commands and Accessories





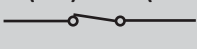
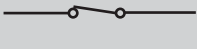
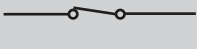
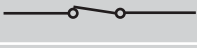

 If not installed, safety devices with NC contacts must be jumpered at the COM terminals, or disabled by modifying the parameters *50*, *51*, *53*, *54*, *73* and *74*.

KEY:

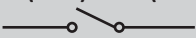
N.A. (Normally Open).

N.C. (Normally Closed).

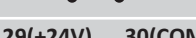
CONTACT	DESCRIPTION
8  9(COR)	Output (potential free contact) for connecting courtesy light. 230 Vac 100 W - 24 Vac/dc 40 W.
10(+SC)  11(COM)	Connection for gate open indicator lamp. 24 Vdc 3 W. The function of the indicator lamp is determined by parameter <i>AB</i> .
10(+SC) 11(COM)	Photocell test connection and/or battery saving. The power feed for the photocell transmitters (TX) may be connected to 10(+SC) . Set the parameter <i>AB 02</i> to enable the test function. Each time a command is received, the control unit switches the photocells off and on to check that the contact changes state correctly. Power feeds for all external devices may be connected to reduce battery consumption (if batteries are used). Set <i>AB 03</i> or <i>AB 04</i> . WARNING! If contact 10(+SC) is used for the photocell test function or battery saving function, a gate open indicator lamp cannot be connected.
12(FT2)  30(COM)	Input (NC) for connecting photocells FT2 (fig. 4, 5 and 6). The photocells FT2 are configured by default with the following settings: – <i>53 00</i> . Photocell FT2 disabled when gate is opening. – <i>54 00</i> . Photocell FT2 disabled when gate is closing. – <i>55 01</i> . The gate opens when an open command is received if photocell FT2 is obstructed. If the photocells are not installed, jumper the terminals 30(COM) - 12(FT2) or set the parameters <i>53 00</i> and <i>54 00</i> . WARNING! Use R90/F4ES , G90/F4ES or T90/F4S series photocells.
13(FT1)  30(COM)	Input (NC) for connecting photocells FT1 (fig. 4, 5 and 6). The photocells FT1 are configured by default with the following settings: – <i>50 00</i> . Photocell triggers only during gate closure. Photocell is ignored during gate opening. – <i>51 02</i> . Movement is reversed if the photocell is triggered during gate closure. – <i>52 01</i> . The gate opens when an open command is received if photocell FT1 is obstructed. If the photocells are not installed, jumper the terminals 30(COM) - 13(FT1) or set the parameters <i>50 00</i> and <i>51 00</i> . WARNING! Use R90/F4ES , G90/F4ES or T90/F4S series photocells.
14(COS2)  16(COM)	Input (NC or 8 kOhm) for connecting sensing edge COS2 . The sensing edge is configured by default with the following settings: – <i>74 00</i> . The sensing edge COS2 (NC contact) is disabled. If the sensing edge is not installed, jumper the terminals 14(COS2) - 16(COM) or set the parameter <i>74 00</i> .
15(COS1)  16(COM)	Input (NC or 8 kOhm) for connecting sensing edge COS1 . The sensing edge is configured by default with the following settings: – <i>73 00</i> . The sensing edge COS1 (NC contact) is disabled. If the sensing edge is not installed, jumper the terminals 15(COS1) - 16(COM) or set the parameter <i>73 00</i> .
17(ST)  16(COM)	STOP command input (NC). The current manoeuvre is arrested if the safety contact opens. N.B.: the controller is supplied with this contact already jumpered by ROGER TECHNOLOGY.
22  21(ANT)	Antenna connector for slot-in radio receiver board. Use RG58 if an external antenna is used; maximum recommended length: 10 m. N.B.: do not make joints in cable.

CONTACT	DESCRIPTION
24(ORO) 23(COM) 	Clock timer contact input (N.O.). When the clock function is active, the gate opens and remains open. At the end of the programmed time set with the external device (clock), the gate closes.
25(AP) 23(COM) 	Open control signal input (N.O.).
26(CH) 23(COM) 	Close command input (N.O.).
27(PP) 23(COM) 	Step by step mode command input (N.O.). The function of the control is determined by parameter <i>R4</i> .
28(PED) 23(COM) 	Partial open control signal input (N.O.). Set by default to 50% of completely open position.
29(+24V) 30(COM)	Power feed for external devices. See technical characteristics.
31(LAM) 30(COM) 	Connection for flashing light (24 Vdc - duty cycle 50%). The settings for the pre-manoeuvre flashing warning signal may be selected with parameter <i>R5</i> , while the flashing mode is set with parameter <i>7B</i> .
ENC	Connector for connecting to encoder installed on motor. WARNING! Always disconnect from electrical power before disconnecting or connecting the encoder cable. N.B.: Ready wired in factory by ROGER TECHNOLOGY.
FC	Connector (N.C. contacts) for connecting mechanical limit switch (see figure 9 - detail B) or magnetic limit switch (see figure 9 - detail C). The gate stops when the limit switch is activated. Adjust the limit switches so that, once triggered, the gate stops slightly before it reaches the mechanical stop. IMPORTANT: repeat the travel acquisition procedure after each adjustment to the limit switches. N.B.: Ready wired in factory by ROGER TECHNOLOGY.
SB	Connector (N.C.) for connecting release contact. If the motor release handle is opened, the gate stops and no command signals are accepted. Once the release handle is closed again and the key turned to the close position, if the gate is in an intermediate position, the control unit initiates the position recovery procedure (see chapter 18). N.B.: Ready wired in factory by ROGER TECHNOLOGY.
RECEIVER CARD	Connector for plug-in radio receiver board. The control unit has two radio remote control functions by default: <ul style="list-style-type: none"> – PR1 - step mode command (modifiable with parameter <i>75</i>). – PR2 - partial opening command (modifiable with parameter <i>77</i>). The programming buttons PR1 and PR2 are also accessible with the cover closed (see figure 7).
BATTERY CHARGER B71/BCHP	Connector for slot-in battery charger board.
BATTERY KIT 2x12 Vdc 4,5 Ah Only AGM type	In the event of a mains power loss, the controller unit is powered by the batteries. When battery power is used, the message <i>bAtE</i> is shown on the display and the flashing light flashes briefly at intervals until mains power is restored or until the battery voltage drops below the minimum permissible limit. In this case, <i>bEL</i> (Battery Low) is shown on the display and the controller unit accepts no commands. If mains power is lost while the gate is moving, the gate stops and then automatically resumes the interrupted manoeuvre after 2 seconds. To reduce battery consumption, the positive power feed wire of the photocell transmitters may be connected to terminal SC (see fig. 5-6). Set <i>AB 03</i> or <i>AB 04</i> . In this configuration, the controller unit disconnects power from the accessory devices when the gate is completely open or completely closed. WARNING! the batteries must always be connected to the electronic controller unit in order to charge. Periodically (at least every 6 months), check that the battery is in good working order. For more information, refer to the installation manual for the B71/BCHP battery charger.

14 Safety input and command status (TEST mode)

With no currently active commands, press the TEST button and check the following:

DISPLAY	POSSIBLE CAUSE	ACTION BY SOFTWARE	PHYSICAL CORRECTIVE ACTION
88 5b(Sb)	The release handle is open.	-	Close the release handle and turn the key to the close position. Check that the release contact is connected correctly.
88 17	The safety STOP contact is open.	-	Install a STOP button (NC) or jumper the ST contact with the COM contact.
88 15	Sensing edge COS1 not connected or incorrectly connected.	Set the parameter 73 00 if not used or to disable	Jumper contact COS1 with contact COM, if not used or to disable
88 14	Sensing edge COS2 not connected or incorrectly connected.	Set the parameter 74 00 if not used or to disable	Jumper contact COS2 with contact COM, if not used or to disable
88 13	Photocell FT1 not connected or incorrectly connected.	Set the parameter 50 00 e 51 00 if not used or to disable	Jumper contact FT1 with contact COM, if not used or to disable. Check connection referring to relative connection diagram (figures 4-5-6).
88 12	Photocell FT2 not connected or incorrectly connected.	Set the parameter 53 00 e 54 00 if not used or to disable	Jumper contact FT2 with contact COM, if not used or to disable. Check connection referring to relative connection diagram (figures 4-5-6).
88 FE	Both limit switches in open contact state or not connected.	-	Check connection of limit switches.
88 FA	Gate is at gate closed limit switch.	If the limit switch state indicated is incorrect, check the setting of parameter 7 l.	-
	Gate open limit switch absent or not connected.	-	Check connection of limit switches.
88 FC	Gate is at gate closed limit switch.	If the limit switch state indicated is incorrect, check the setting of parameter 7 l.	-
	Gate closed limit switch absent or not connected.	-	Check connection of limit switches.
PP 00	If occurs with no voluntary command, the contact (N.O.) may be faulty or one of the buttons may be incorrectly connected.	-	Check PP - COM contacts and connections to buttons.
CH 00		-	Check CH - COM contacts and connections to buttons.
AP 00		-	Check AP - COM contacts and connections to buttons.
PE 00		-	Check PED - COM contacts and connections to buttons.
OR 00	If occurs with no voluntary command, the contact (N.O.) may be faulty or the timer may be incorrectly connected.	-	Check ORO - COM contacts. Contact must not be jumpered if not used.

N.B: press TEST to exit TEST mode.

We recommend troubleshooting safety device and input status errors with “corrective action by software” only.

15 Alarms and faults

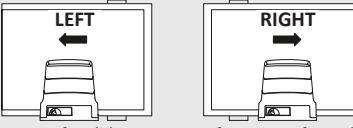
PROBLEM	ALARM	POSSIBLE CAUSE	ACTION	
The gate does not open or close.	LED POWER off	No power.	Check power cable.	
	LED POWER off	Fuses blown.	Replace fuses. Always disconnect from mains power before removing fuses.	
	DF St	Input mains power voltage fault. Control initialisation failed.	Disconnect from mains power, wait 10 seconds then reconnect to the mains and switch on. We recommend replacing the control unit if the problem persists.	
	FUSE	Fuse F1 blown or damaged. This message is not visible if controller is in battery power mode.	Replace fuse. Always disconnect from mains power before removing and refitting fuses.	
	Pr Ot	Overcurrent detected in inverter.	Press the TEST button twice or perform 3 command requests in succession.	
	SECO	Incorrect connection to transformer SEC1-SEC2.	Swap connections between SEC1 and SEC2.	
	dAtA	Travel data acquisition error.	Check that open and closed limit switches are positioned correctly. Press TEST and check if any safety devices are in alarm state. Repeat acquisition procedure.	
		Calibration procedure failed.	Allow the indicated calibration times to elapse during self-acquisition. Check that <i>PHAS</i> is shown flashing on the display before closing the release lock cover. Repeat acquisition procedure.	
		Automation system position selection modification message with parameter 71.	 <p>Motors for sliding gates are factory configured for right hand opening gates 7101 gates (position of motor relative to passage seen from interior side). If the position is changed and message <i>dAtA</i> is displayed:</p> <ul style="list-style-type: none"> • Move the gate into the closed position. • Disconnect from mains power or remove the main fuse and wait 5 seconds. • Reconnect to mains power or refit the fuse. • Press and hold PROG until <i>dAtA</i> disappears and <i>APPL</i> appears on the display. <p>Repeat acquisition procedure.</p>	
		Not	Motor not connected.	Check the motor cable.
		FE	Both limit switches activated.	Check connections of limit switches or check for foreign objects in limit switch blocks.
		Example: 15 EE 21 EE	Configuration parameter error.	Set configuration value correctly and save.
		EnE1	Encoder not connected.	Check connection to encoder. Replacing the encoder is recommended if the problem persists.
		EnE3	Severe encoder malfunction.	Press TEST button. If the error code is displayed again, switch off the controller unit, wait 5 seconds and switch on again. Replace the encoder if the problem persists.
		EnE5(EnE5)	Encoder malfunction.	Press TEST button. Replace the encoder if the problem persists.
		Insufficient power supply	If the unit contains dirt, moisture, insects or other foreign matter, disconnect from mains power and clean the board and the encoder. Replace the encoder if the problem persists.	
		Batteries functioning	The batteries are almost flat.	
	EnE8	Encoder calculation error.	Repeat acquisition procedure.	

PROBLEM	ALARM	POSSIBLE CAUSE	ACTION
The gate does not open or close.	<i>tENP</i>	Inverter thermal overload circuit breaker tripped.	Function is restored automatically within 2 min.
	<i>btLO (btLO)</i>	Flat batteries.	Wait for mains power to be restored.
	<i>STOP</i> flashing	Release device open.	Close the release handle and turn the key to the close position. Check that the release contact is connected correctly.
Acquisition procedure does not complete correctly.	<i>no PH</i>	Motor calibration failed.	Repeat acquisition procedure. If the problem persists, check the cable connecting the encoder to the motor. Check if release handle is open. Check that the motor turns without impediment. Contact technical support in case of any problems.
	<i>AP PE</i>	TEST button pressed accidentally.	Repeat acquisition procedure.
		Safety devices in alarm state.	Check connections of safety devices.
		Excessive voltage drop.	Repeat acquisition procedure. Check mains voltage.
		Incorrect setting of parameters <i>30</i> and <i>31</i> .	Adjust parameters <i>30</i> and <i>31</i> correctly for the weight and speed of the gate leaf.
Acquisition procedure does not complete correctly.	<i>AP PL</i>	Travel length error.	Move gate into completely closed position (FC limit switch signal must be active) and repeat the procedure. Check cable of limit switches. Replace the cable if the problem persists. Reset default controller unit parameters and repeat the procedure.
Remote control has limited range and does not work while automated gate is moving.	-	The radio transmission is impeded by metal structures and reinforced concrete walls.	Install the antenna outside.
	-	Flat batteries.	Replace the transmitter batteries.
The flashing light is not working.	-	Bulb / LED blown or flashing light wires disconnected.	Check LED circuit and/or connector wires.
Gate open indicator lamp does not work.	-	Bulb blown or wires disconnected.	Check the bulb and/or wires.
Gate does not perform desired manoeuvre.	-	Incorrect setting of parameter <i>71</i> .	Select the correct installation position with parameter <i>71</i> .

N.B.: Press the TEST button to temporarily cancel the alarm.

The next time a command is received, the alarm reappears on the display if the problem has not been resolved.

16 Procedural verifications - INFO Mode

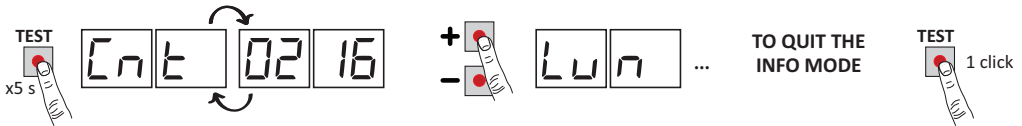

INFO mode may be used to view certain parameters measured by the **B70/1DCHP** controller.

Press and hold the TEST button for 5 seconds from the “View command signals and safety devices” mode with the motor stationary.

The control unit displays the following parameters and the corresponding measured values in sequence:

Parameter	Function
r 1.22	View for 3 s the firmware version of the control unit.
Cnt	Displays the position of MOTOR, expressed in revolutions and relative to total length, at the time of the test. (example: 0 113 = motor installed on the left 71 00; 0 113 = motor installed on the right 71 0 1).
Lun	View total length of programmed travel of MOTOR, in motor revolutions.
r PPM	View motor speed of MOTOR, in revolutions per minute (rPM).
AMP	View current absorption of motor, in Amperes (e.g.: 001.1 = 1,1 A ... 016.5 = 16,5 A). If the MOTOR is stationary, the current absorption value is 0. Activate a command function to test current absorption.
bUS	System OK indicator. To check for overloading (e.g.: too many utilities connected to 24 V output) or if the mains voltage is too low, compare the parameters read with values indicated as follows with the motor stationary: mains voltage = 230 V AC (nominal), bUS= 37.5 mains voltage = 207 V AC (-10%), bUS= 33.6 mains voltage = 253 V AC (+10%), bUS= 41.6
CNP	Display current, expressed in Amperes, used to compensate for strain detected by MOTOR due, for example, to low external temperatures (e.g.: 0 = 0 A ... 4 = +12 A). At the beginning of a manoeuvre from the completely open or completely closed position, if the control unit detects a strain higher than the value stored in its memory during the travel acquisition cycle, the controller automatically increases the current delivered to MOTOR.
ASC	Display current threshold, expressed in Amperes, at which the obstacle detection function (crush prevention) of MOTOR is triggered. This value is calculated automatically by the controller in relation to the settings of parameters 30 and 31. For the motor to function correctly, AMP must always be lower than the value ASC.
Et n	Indicates time taken by MOTOR to detect an obstacle, as set with parameter 31, in seconds. E.g. 1.000 = 1 s / 0.120 = 0.12 s (120 ms). Ensure that the manoeuvre time is more than 0.3 s.
UP	If the control unit is capable of identifying the position of the gate when the test is conducted, the following is shown on the display: UP _ position known, normal operation. UP L position unknown, position recovery in progress.
OC	Indicates the state of the automation system (open/closed). OC OP automation system opening (motor active). OC CL automation system closing (motor active). OC -0 automation system completely open (motor not actives). OC -C automation system completely closed (motor not actives).
UF	UF U mains voltage too low or overload. UF H motors overcurrent.

- Use the + / - buttons to scroll through the parameters. When the last parameter in the sequence is reached, press the - button to return through the previous parameters.
- In INFO mode, the automation system may be activated to test operation in real time.
- Press and hold the TEST button for a few seconds to exit INFO mode.

17 Mechanical release

In the event of a power failure, the gate may be released as follows.
If the gate releases with the controller unit powered, the message *5L0P* flashes on the display.

- Flip open the lock cover (1).
- Insert the key included into the lock and turn clockwise by 90° (2).
- Open the release cover completely (3).
- Move the gate manually.

RESTORING AUTOMATIC OPERATION

- Close the release cover with the key inserted, taking care not to trap your fingers (1).
- Turn the key anticlockwise by 90° (2).
- Remove the key and close the lock cover (3).
- When the release system is restored to the normal operating position, if the gate is not completely open or completely closed the next time a command is received, the control initiates a position recovery procedure (see chapter 18).
- Activating one of the two limit switches immediately reacquires the position.

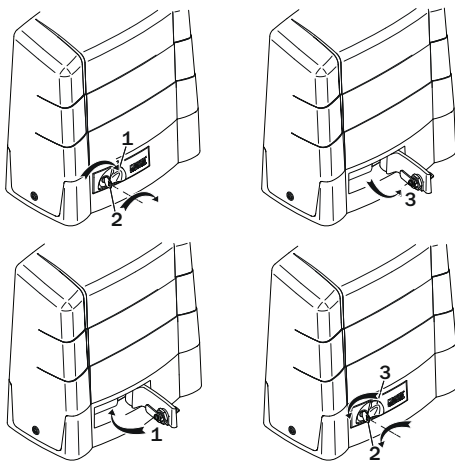

18 Position recovery mode

After a mains power outage or after mechanically releasing the gate, if the gate is not completely open or completely closed the next time a command is received, the control initiates a position recovery procedure:

- The gate starts a low speed manoeuvre.
- The flashing light flashes with a different duty cycle than normal (3 s on, 1.5 s off).
- The control unit recovers the installation data during this procedure. **Warning!** During this procedure, do not use any controls until one of the two limit switches is reached.
- Activating one of the two limit switches immediately reacquires the position.

When the control unit receives a command signal after a power failure or after the motor has been mechanically released, if the gate is completely open or completely closed, it initiates a position recovery procedure to precisely determine the exact position of the gate.

The gate clears the limit switch, stops briefly and then resumes the manoeuvre until it reaches the opposite limit switch at reduced speed (regardless of the settings of parameters 13, 14 and 42), to restore position control with absolute precision. For **BG30/1400/R** motors only. If the control unit detects that the gate has been moved manually by more than 3 cm from the initial position, it initiates a position recovery procedure.

19 Initial testing

- Turn on the power supply.
- Check that all connected controls are working correctly.
- Check that the release handle works correctly. The message *5L0P* must flash on the display.
- Check travel and deceleration.
- Check that the impact force is correct, in compliance with EN 12453 and EN12445.
- Check that the safety devices are activated correctly.
- If the battery kit is installed, disconnect from mains and check that the batteries are working.
- Disconnect from mains power and disconnect the batteries (if used), then reconnect. Starting with the gate stopped in an intermediate position, check that the position recovery procedure is completed correctly for both the open and closed positions.
- Check the limit switch settings.

20 Maintenance

Perform scheduled maintenance every 6 months.

Check cleanliness and function.

If the unit contains dirt, moisture, insects or other foreign matter, disconnect from mains power and clean the board and the housing.

Repeat the initial installation test procedure after cleaning.

If any corrosion is found on the printed circuit board, evaluate if it is necessary to replace the board itself.

Check that the battery is in good working order.

21 Disposal



This product may only be uninstalled by qualified technical personnel, following suitable procedures for removing the product correctly and safely. This product consists of numerous different materials. Some of these materials may be recycled, while others must be disposed of correctly at the specific recycling or waste management facilities indicated by local legislation applicable for this category of product.

Do not dispose of this product as domestic refuse. Observe local legislation for differentiated refuse collection, or hand the product over to the vendor when purchasing an equivalent new product.

Local legislation may envisage severe fines for the incorrect disposal of this product.

Warning! Some parts of this product may contain substances that are harmful to the environment or dangerous and which may cause damage to the environment or health risks if disposed of incorrectly.

22 Additional information and contact details

ROGER TECHNOLOGY is the exclusive proprietor holder of all rights regarding this publication.

ROGER TECHNOLOGY reserves the right to implement any modifications without prior notification. Copying, scanning or any alterations to this document are prohibited without express prior authorised from by ROGER TECHNOLOGY.

This instruction manual and the warnings for the installer are given in printed form and included in the box containing the product.

The digital version of this documentation (in PDF format) and all future revisions are available from the reserved area of our website www.rogertechnology.com/B2B, in the section 'Self Service'.

ROGER TECHNOLOGY CUSTOMER SERVICE:

business hours: Monday to Friday
08:00 to 12:00 - 13:30 to 17:30

Telephone no: +39 041 5937023

E-mail: service@rogertechnology.it

Skype: service_rogertechnology

To request support for any problems or for any other queries regarding the automation system, please compile the online form "REPAIRS" in the 'Self Service' area of our website www.rogertechnology.com/B2B.

23 Declaration of Conformity

I the undersigned, as acting legal representative of the manufacturer
Roger Technology - Via Botticelli 8, 31021 Bonisiolo di Mogliano V.to (TV)

hereby DECLARE that the appliance described below:

Description: Controller unit for automatic gates

Model: **B70/1DCHP**

Is conformant with the legal requisites of the following directives:

- 2006/42/EC

- 2004/108/CE

- 2011/65/EC

and that all the standards and/or technical requirements indicated as follows have been applied:

EN 61000-6-3

EN 61000-6-2

Last two figures of year in which marking was applied C€ 16.

Place: Mogliano V.to

Date: 02/05/2016

Signature